

EVERYTHING 150 SQUARE TRIMLESS

Ernesto Gismondi

SUBMITTAL FORM

#CAT	SERIE	TYPE	SHAPE	MOUNTING	CCT	BEAM	COLOR
USC-AEVH	15	—	S	TL	—	—	C

QUANTITY

Serie	15 = Everything 150
Type	A = Adjustable D = Downlight
Mounting	TL = Trimless
CCT	27 = 2700K / 90CRI 30 = 3000K / 90CRI 35 = 3500K / 90CRI
Beam angle	SP = 18 deg NF = 28 deg
Cone color	C = Chrome reflector

MODEL 150 IS ONLY AVAILABLE WITH SPOT AND NARROW FLOOD OPTICS

TECHNICAL DATA:

Everything 150 Round / Square	90CRI					
	2700K		3000K		3500K	
Beam angle:	18°	28°	18°	28°	18°	28°
Power consumption:	30W					
Lumen Nominal:	2645lm		2763lm		2817lm	
Lumen Delivered:	2327	1812	2431	1892	2479	1930
Efficacy lm/W:	78	60	81	63	83	64
Efficiency (%):	88%	69%	88%	69%	88%	69%

FEATURES:

Construction :

Light module: Plaster frame. Thermoplastic housing. Provide with quick connector for easy connection with power pack.

Frame: NON-IC New construction mounting frame. (see page 2)

Weight: 0.56lbs (0.25Kg)

Label:  ^{us} - suitable for dry locations

Class: IP20 

PHOTOMETRIC DATA:

3000K SHOWN DATA

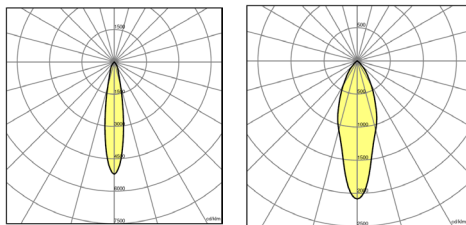

Max Candela: 5208 cd/klm
Everything 150 30K 18° CH
V = 0° H = 0°

Max Candela: 2083 cd/klm
Everything 150 30K 28° CH
V = 0° H = 0°

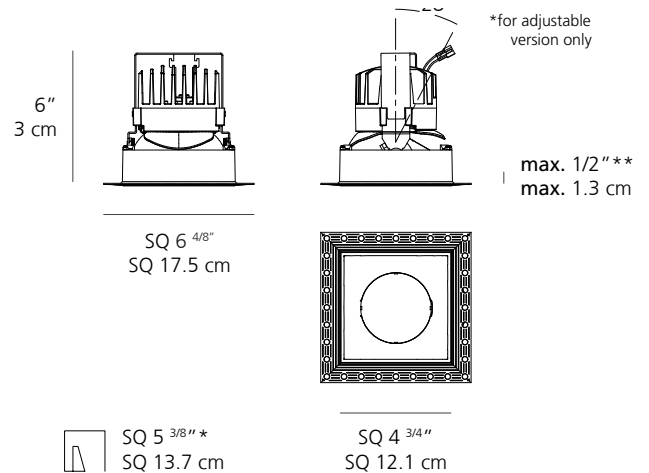
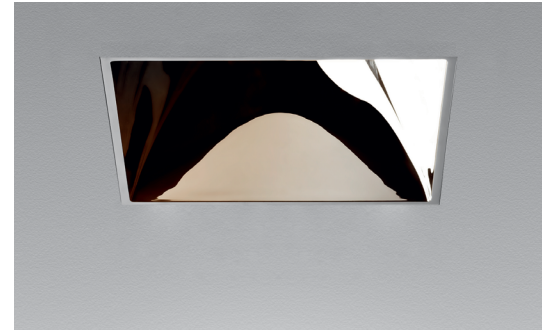

Project Name		
Floorplan Ref. Type		
Quantity		
Notes		
Date		
Signature & Stamp		

EVERYTHING 150 SQUARE INSTALLATION

Ernesto Gismondi

NEW CONSTRUCTION FRAME:

#CAT	SERIE	SHAPE	MOUNTING	DRIVER	QUANTITY
USC-AEVF	15	S	N	—	

Serie	15 = Everything 150
Shape	S = Square
mounting	N = New construction frame (NON-IC)
Driver	11 = 0-10V (120V only) 12 = 0-10V (277V only)

Construction :

Galvanized steel frame.

Alignment details available on each side of the frame for precision.

For wood joist and grid ceilings.

Mounting bar extends from 14 3/8" to 26" (360- 660mm).

Easy driver replacement from ceiling aperture.

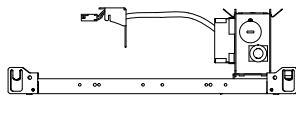

15"
38.1 cm

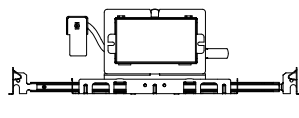

4 1/2"
11.4 cm

14 1/2"
37 cm
to
26"
66 cm

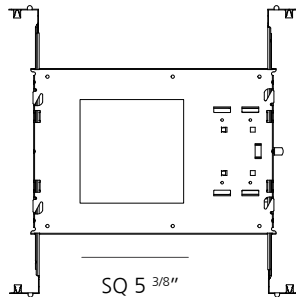

SQ 5 3/8"
SQ 13.7 cm