

## EVERYTHING 105 SQUARE TRIM

Ernesto Gismondi

## SUBMITTAL FORM

#CAT	SERIE	TYPE	SHAPE	MOUNTIG	CCT	BEAM	CONE	TRIM
USC-AEVH	10	___	S	TR	___	___	C	___

QUANTITY

Serie	<b>10</b> = Everything 105
Type	<b>A</b> = Adjustable <b>D</b> = Downlight
Mounting	<b>TR</b> = Trim
CCT	<b>27</b> = 2700K / 90CRI <b>30</b> = 3000K / 90CRI <b>35</b> = 3500K / 90CRI
Beam angle	<b>SP</b> = 25 deg <b>NF</b> = 28 deg
Cone color	<b>C</b> = Chrome reflector
Trim color	<b>W</b> = White <b>S</b> = Silver

MODEL 105 IS ONLY AVAILABLE WITH SPOT AND NARROW FLOOD OPTICS

### TECHNICAL DATA:

Everything 105 Round / Square	90CRI					
	2700K		3000K		3500K	
Beam angle:	25°	28°	25°	28°	25°	28°
Power consumption:	15W					
Lumen Nominal:	1330lm		1390lm		1415lm	
Lumen Delivered:	934	674	976	705	993	717
Efficacy lm/W:	62	45	65	47	66	48
Efficiency (%):	70%	51%	70%	51%	70%	51%

### FEATURES:

#### Construction :

**Light module:** Thermoplastic housing. Provide with quick connector for easy connection with power pack or new construction frame.

**Frame:** NON-IC remodeler power pack. New construction mounting frame. (see page 2)

**Weight:** 0.56lbs (0.25Kg)

Label:  - suitable for dry locations

Class: IP20 

### PHOTOMETRIC DATA:

3000K SHOWN DATA

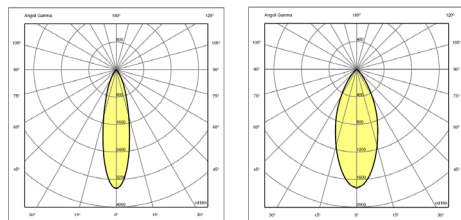

Max Candela: 3458 cd/klm  
Everything 105 30K 25° CH  
V = 0° H = 0°

Max Candela: 1723 cd/klm  
Everything 105 30K 28° CH  
V = 0° H = 0°

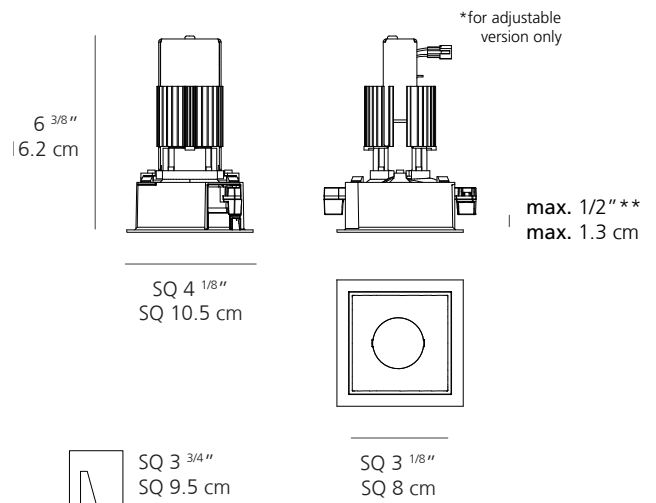

Project Name	
Floorplan Ref. Type	
Quantity	
Notes	
Date	
Signature & Stamp	

## EVERYTHING 105 SQUARE INSTALLATION

Ernesto Gismondi

### REMODELER POWER PACK:

#CAT	SERIE	MOUNTING	DRIVER	QUANTITY
USC-AEVF	8010	R	—	

Serie	<b>8010</b> = Everything 80 /105
mounting	<b>R</b> = Remodeler
Driver	<b>06</b> = Phase dimming (120V only) (277V ON/OFF only) <b>08</b> = 0-10V dimming (120/ 277V)

Construction :  
Minimum ceiling height 8"  
Galvanized steel frame.

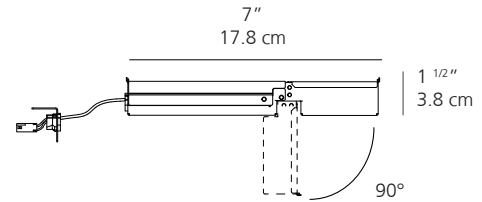
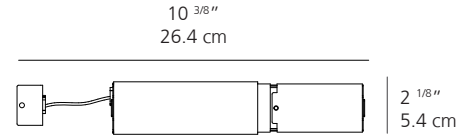

### NEW CONSTRUCTION FRAME:

#CAT	SERIE	SHAPE	MOUNTING	DRIVER	QUANTITY
USC-AEVF	10	S	N	—	

Serie	<b>10</b> = Everything 105
Shape	<b>S</b> = Square
mounting	<b>N</b> = New construction frame (NON-IC)
Driver	<b>11</b> = 0-10V (120V only) <b>12</b> = 0-10V (277V only)

Construction :  
Galvanized steel frame.  
Alignment details available on each side of the frame for precision.  
For wood joist and grid ceilings.  
Mounting bar extends from 14 3/8" to 26" (360- 660mm).  
Easy driver replacement from ceiling aperture.

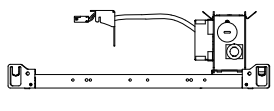

15"  
38.1 cm

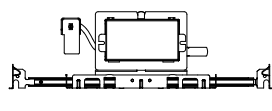

4 1/2"  
11.4 cm

14 1/2"  
37 cm  
to  
26"  
66 cm

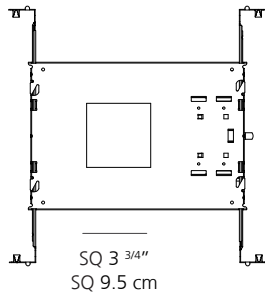

SQ 3 3/4"  
SQ 9.5 cm