

“O” Floor

design
Elemental

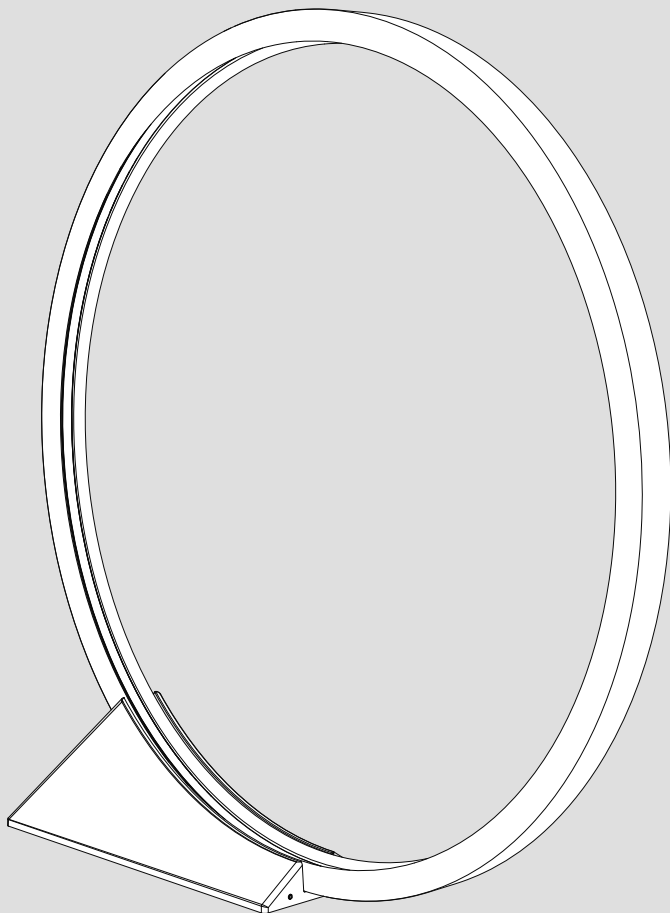

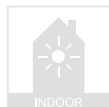

i

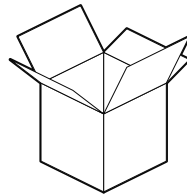
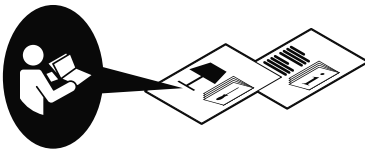

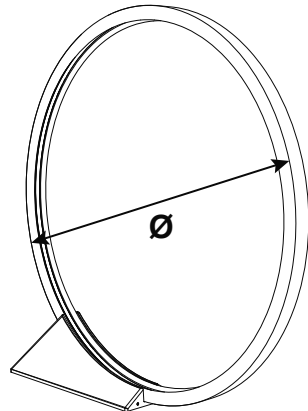

T071038	Ø = 900 mm
T071238	Ø = 1500 mm



i

T071038

U out 24 V 
Max Power 60 W
Max Current 2,5 A



Use only with class 2 power unit
Utiliser exclusivement avec class 2 alimentation
Utilícese únicamente con unidad de alimentación de clase 2

MAX 4 m



i

T071238

U out 24 V 
Max Power 90 W
Max Current 3,75 A

Use only with class 2 power unit
Utiliser exclusivement avec class 2 alimentation
Utilícese únicamente con unidad de alimentación de clase 2

MAX 4 m

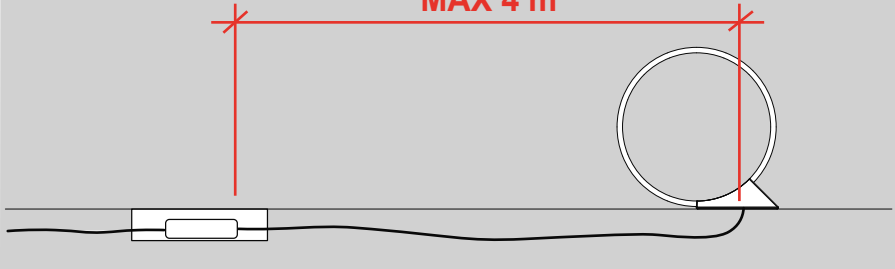

1

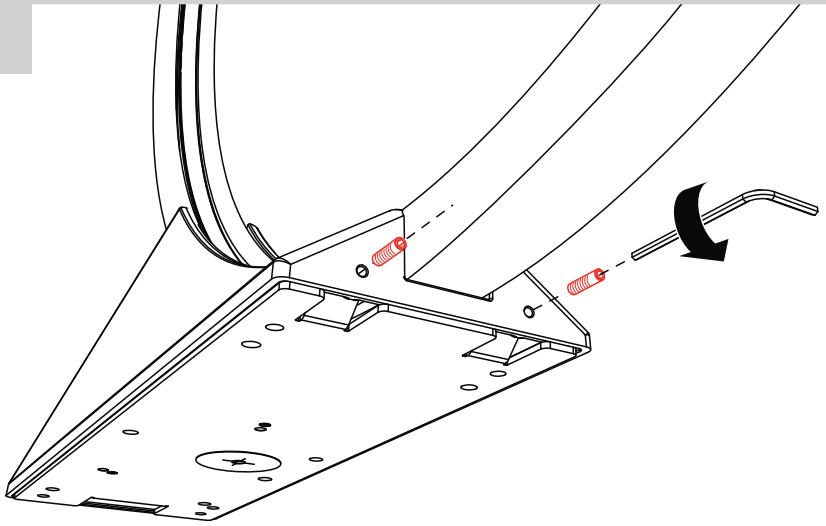

2

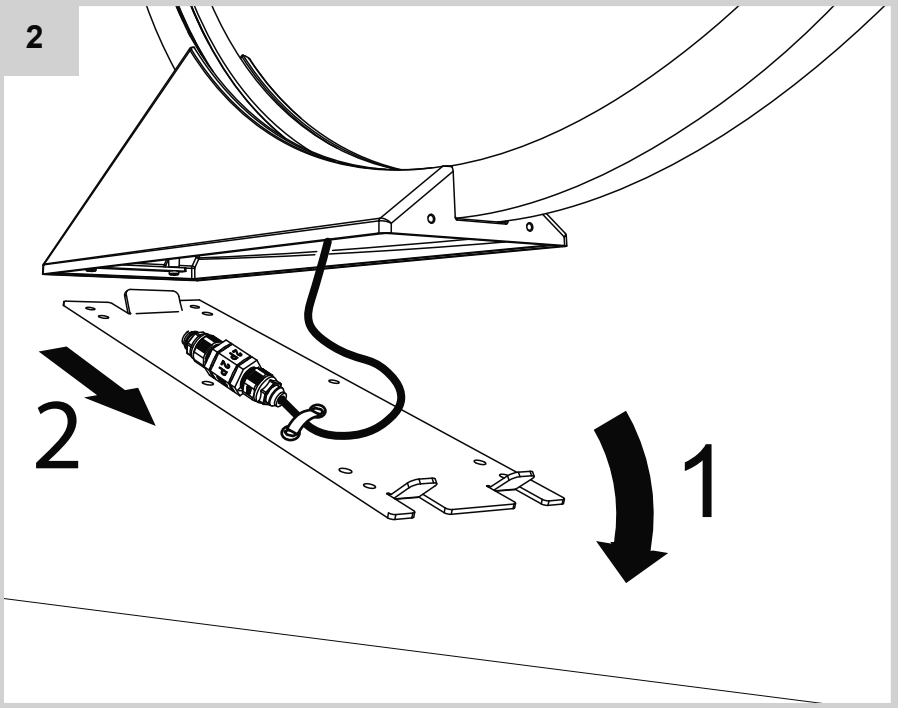

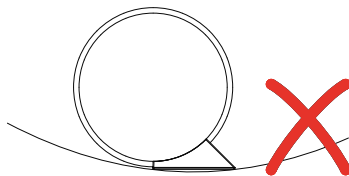
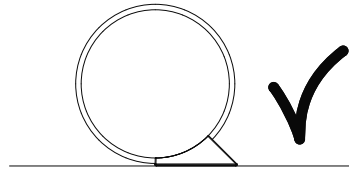
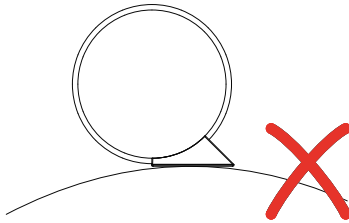
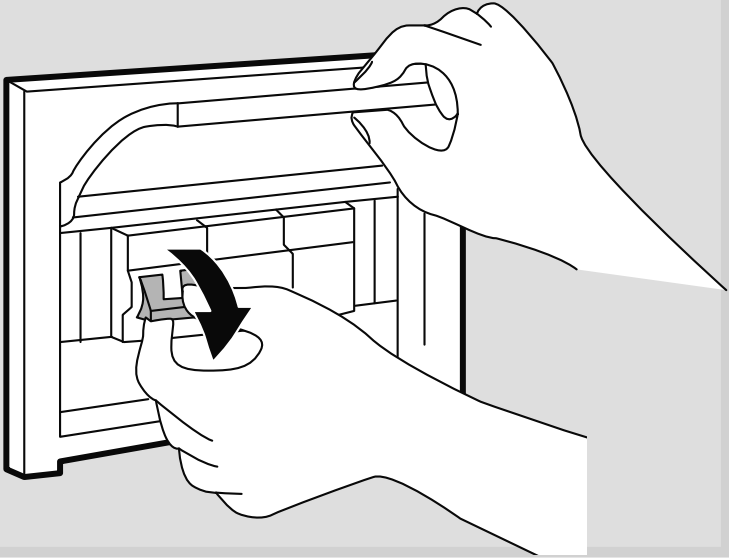

3

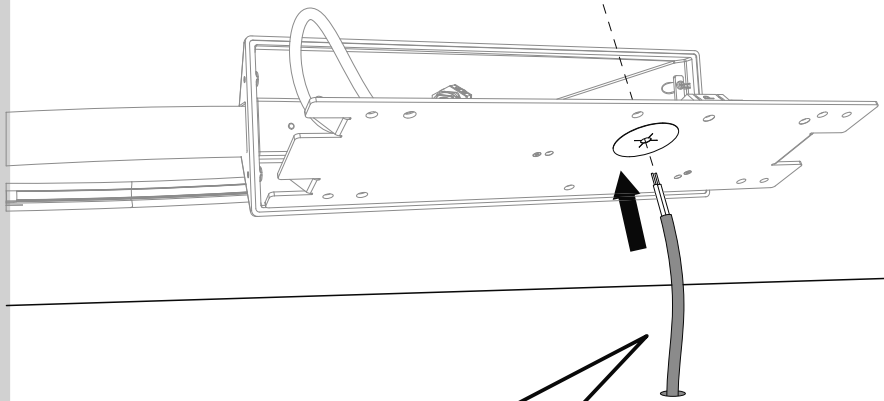

SJTW 2XAWG18

Ø 7 - 13.5 mm

20 mm

8 mm

4

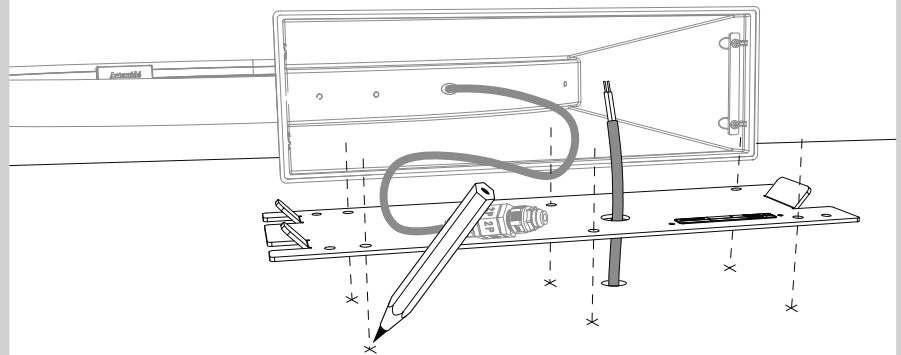

5

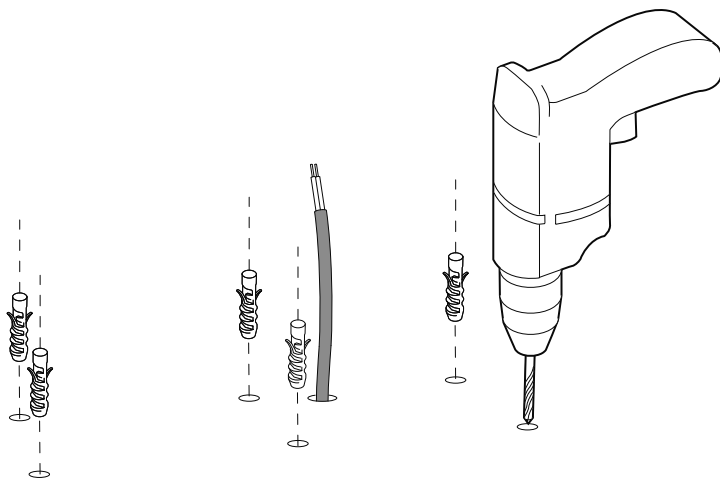

6

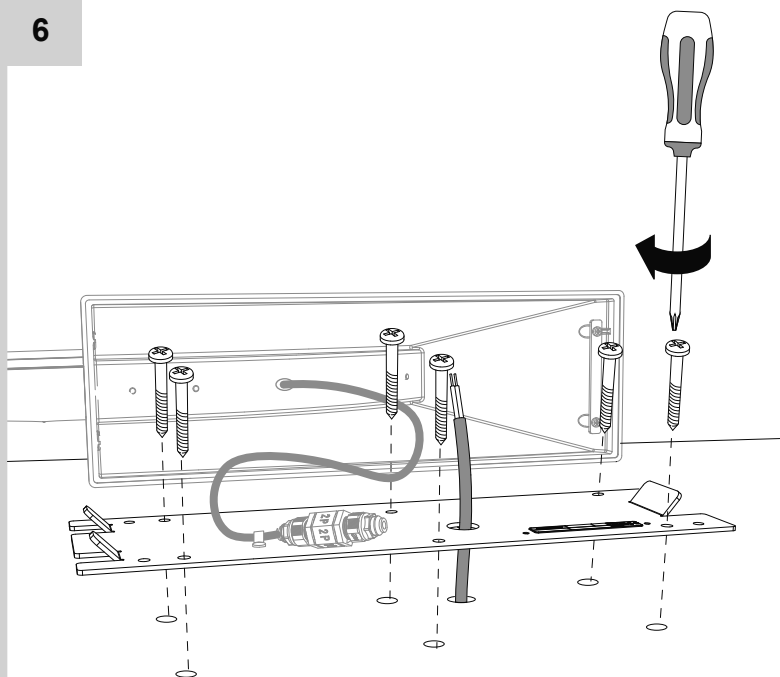

7

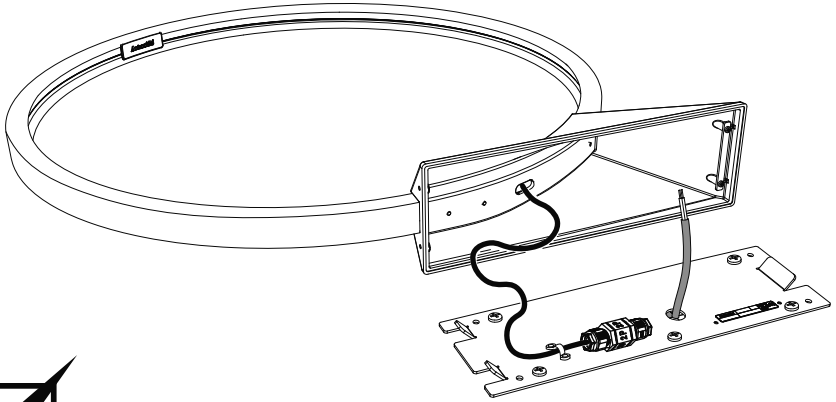

8

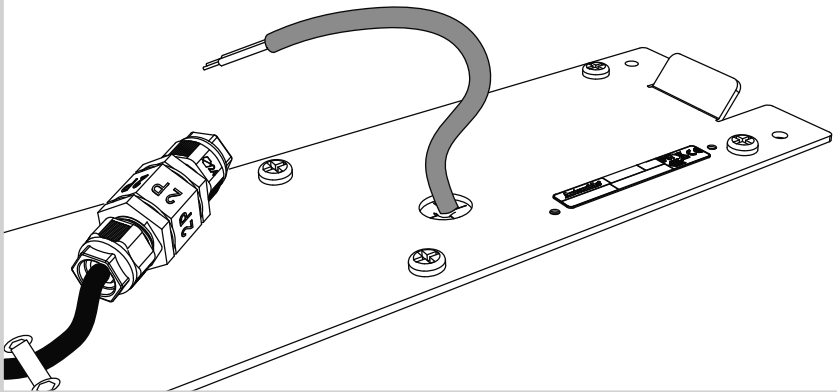

9

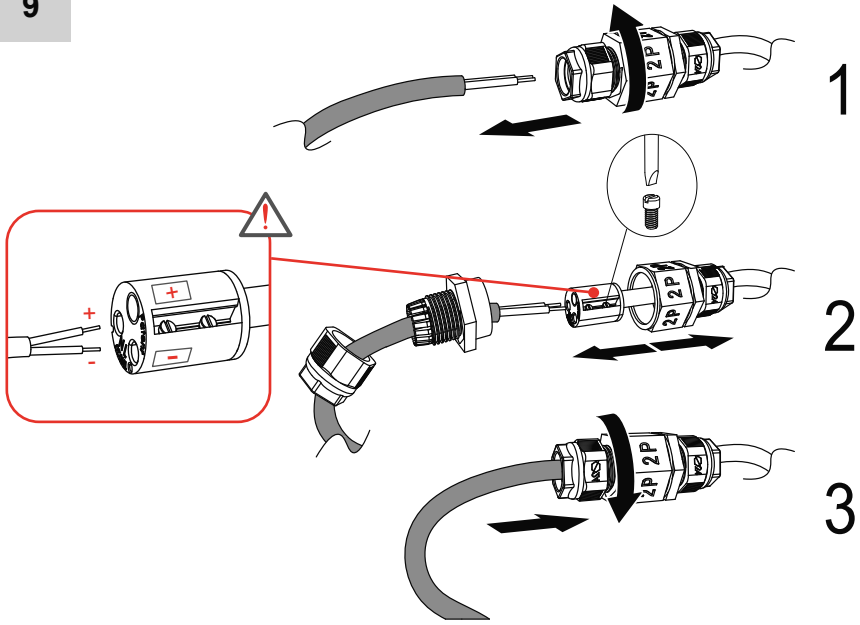

10

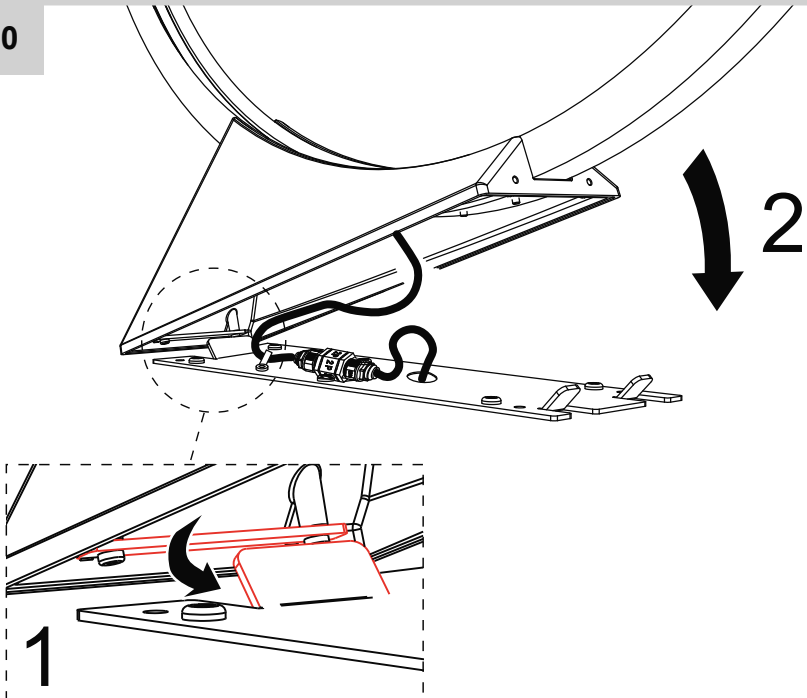

11

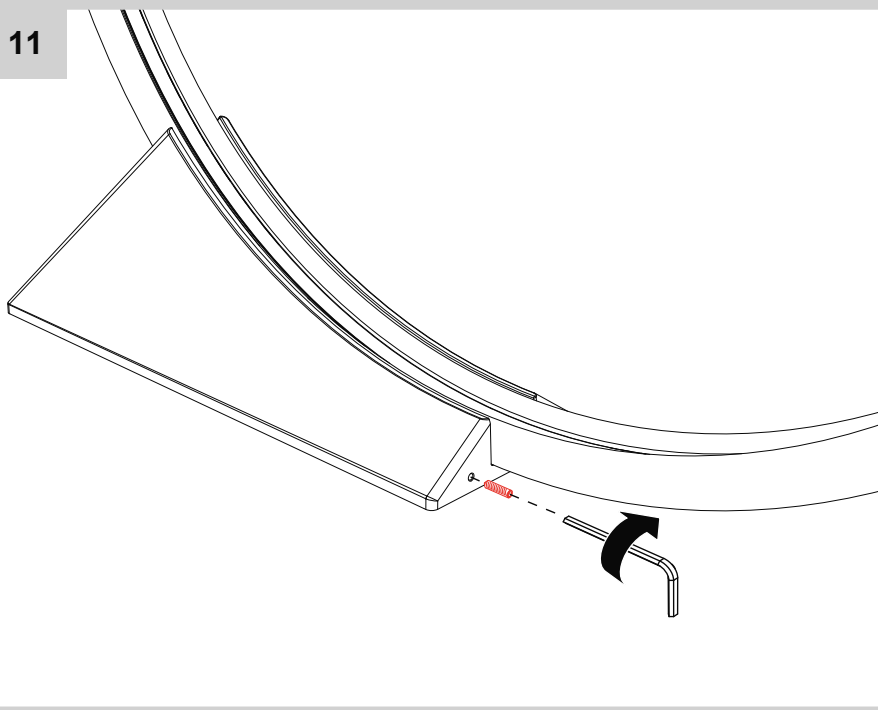

12

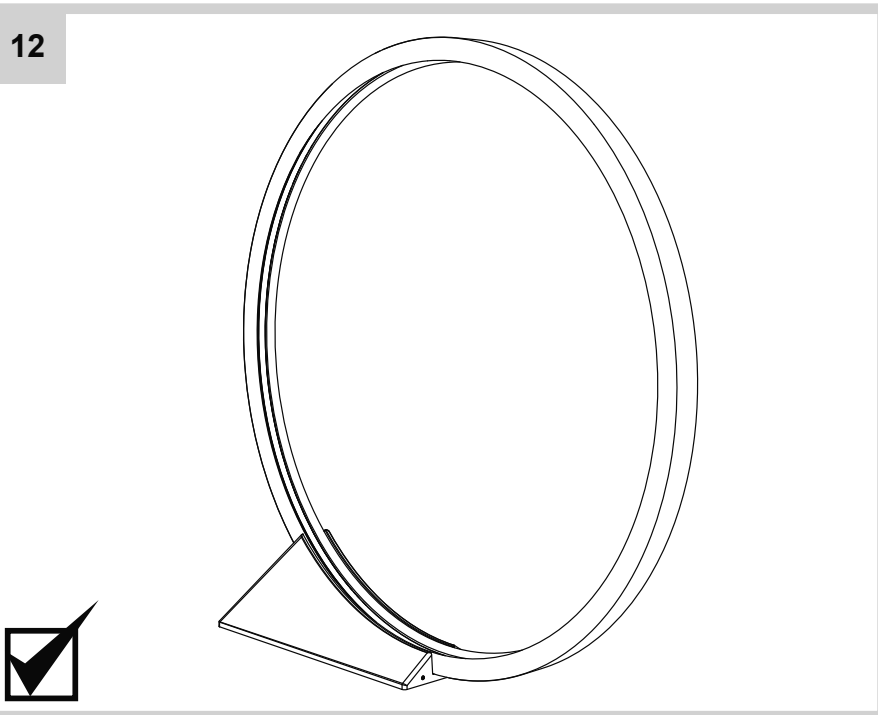

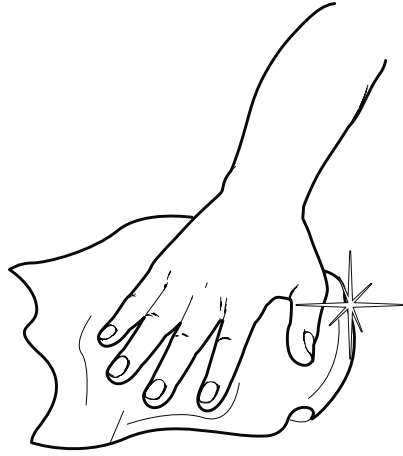
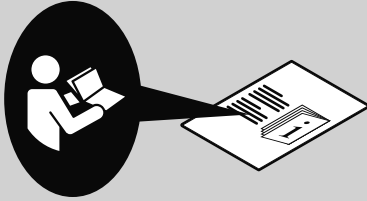

Artemide®

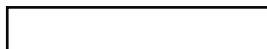

Artemide

via Bergamo, 18
20010 Pregnana M.se (MI)
ITALIA

tel. +39 02 935 181
fax +39 02 935 90 254
fax +39 02 935 90 496

www.artemide.com

VAT IT00846890150

cod. Y513001228A