

Artemide®

Tigia

design
Pio & Tito Toso





i

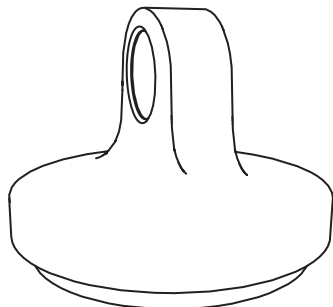
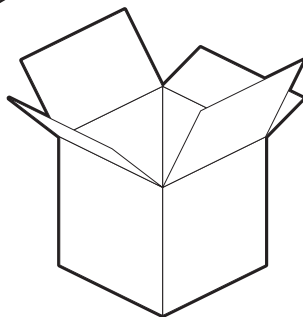
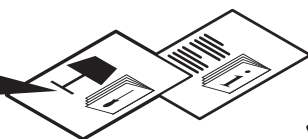

1

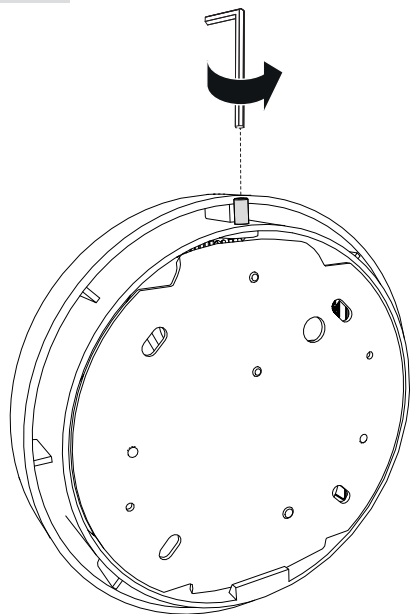

2

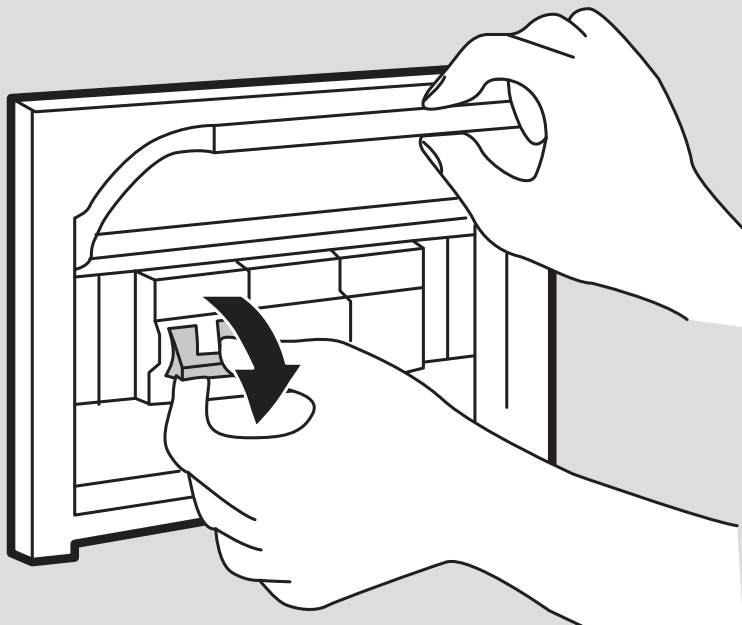
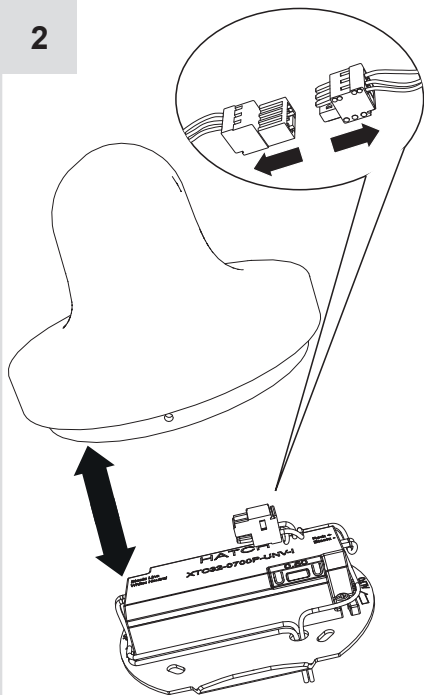

3a



120-277 V

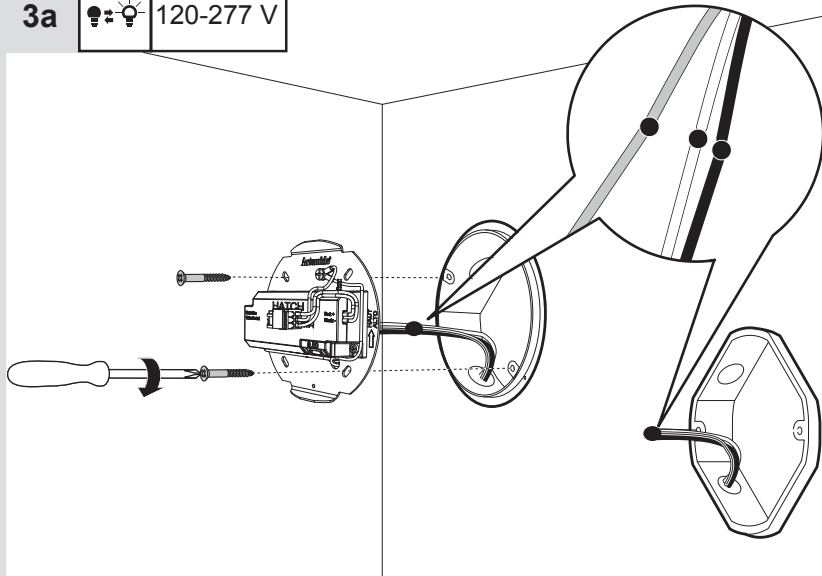

white/blanc/blanco		white/blanc/blanco
green/vert/verde		green/vert/verde
black/noir/negro		black/noir/negro

3b



120 V

Phase cut
Coupure de phase
Corte de fase

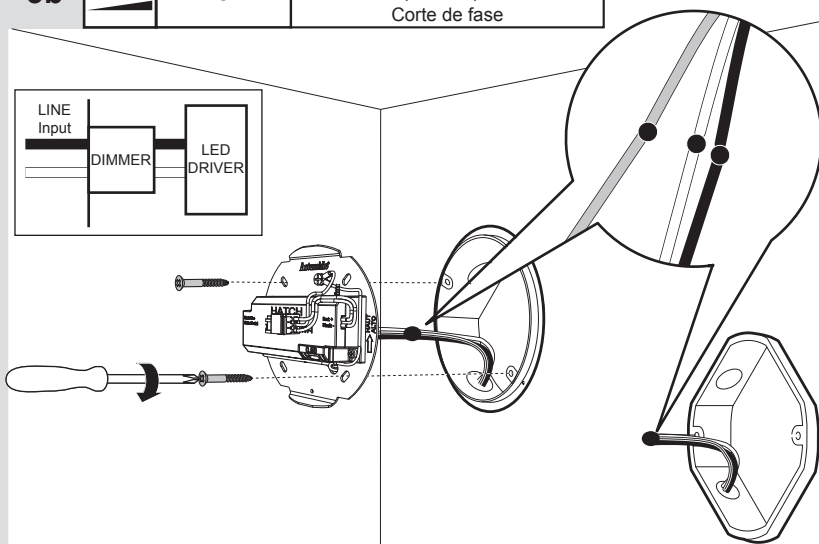
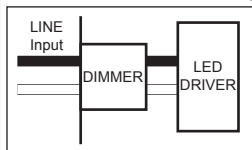

white/blanc/blanco		white/blanc/blanco
green/vert/verde		green/vert/verde
black/noir/negro		black/noir/negro

4

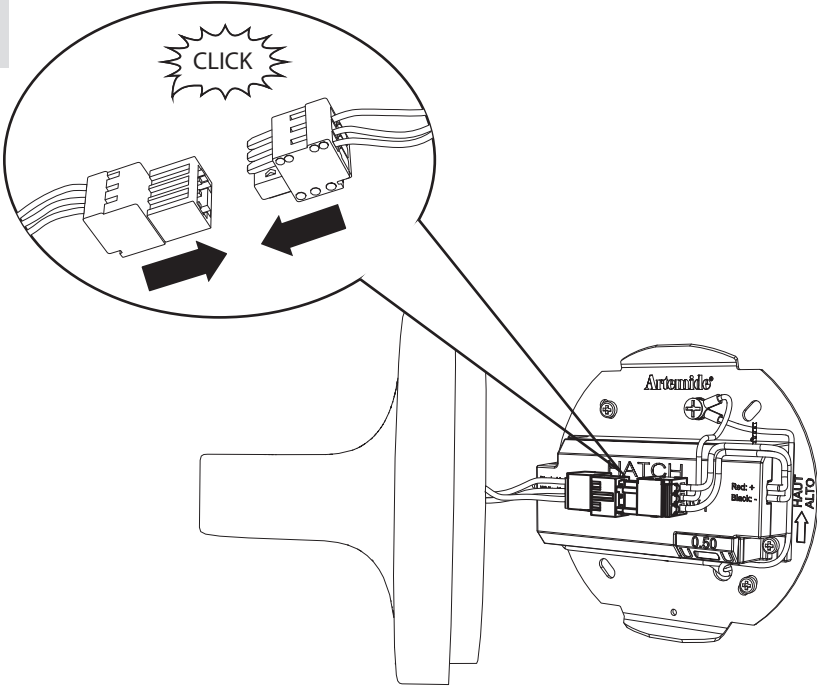

5

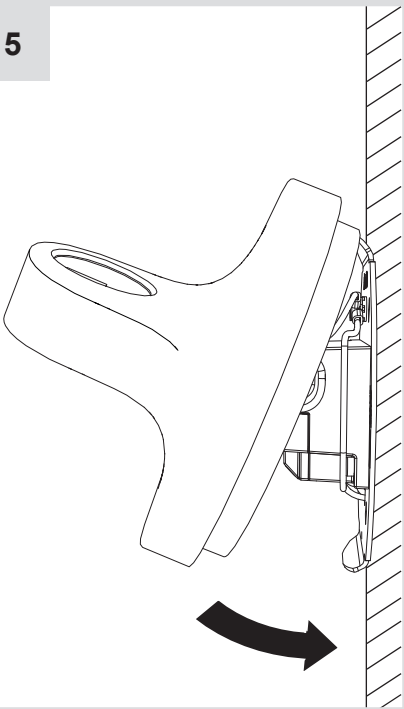

6

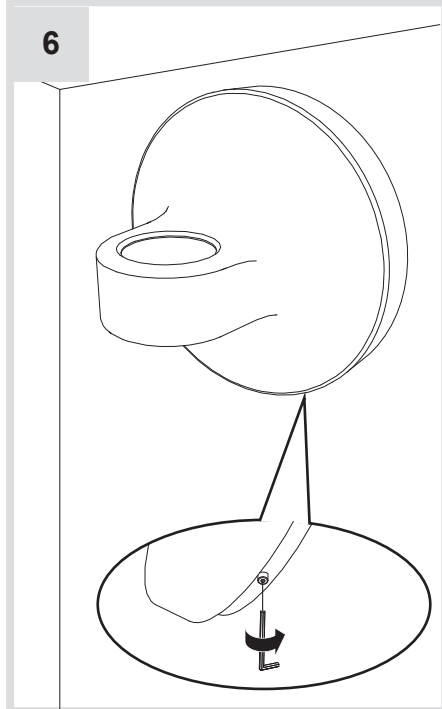

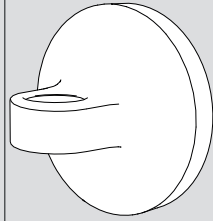

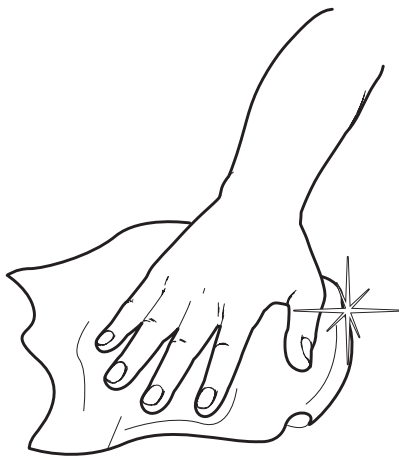
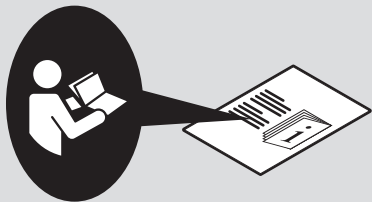

Artemide®

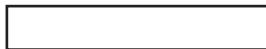

Artemide

via Bergamo, 18
20010 Pregnana M.se (MI)
ITALIA

tel. +39 02 935 181
fax +39 02 935 90 254
fax +39 02 935 90 496

www.artemide.com

VAT IT00846890150

Artemide Inc.

250 Karin Lane
Hicksville, NY 11801

Tel. 631 694 9292
Toll Free 1-877-Art-9111
Fax 631 694 9275

www.artemide.net

Artemide Ltée/Ltd.

11105 rue Renaude Lapointe
Montréal, Québec H1J 2T4

Tel. 514 323 6537
Toll Free 888 777 2783
Fax 514 323 8864

www.artemide.net

cod. Y513000480