

Artemide®

DIOSCURI

design
Michele De Lucchi

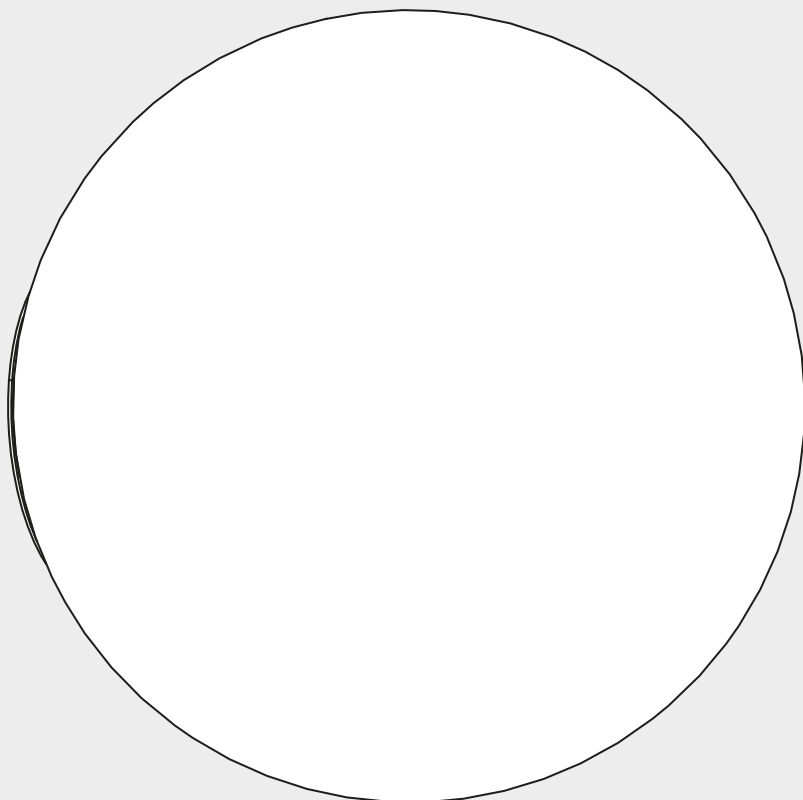



i

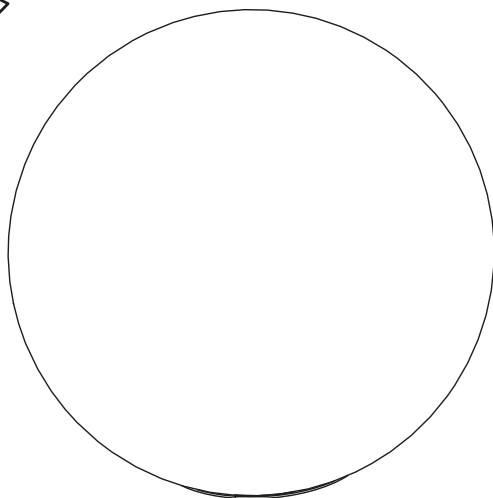
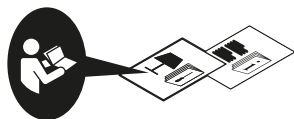
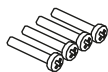
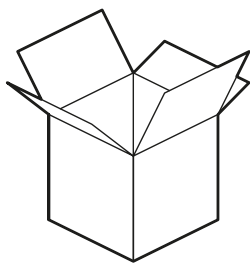

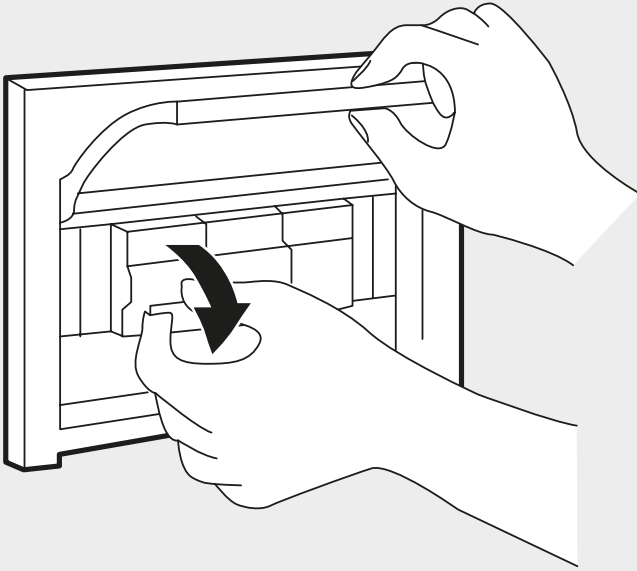



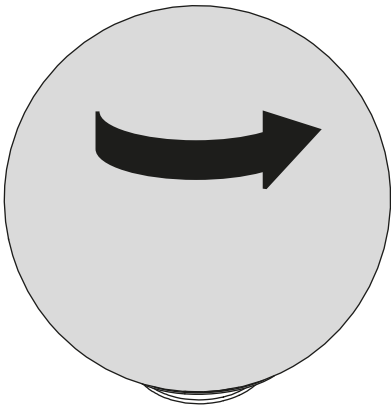

1

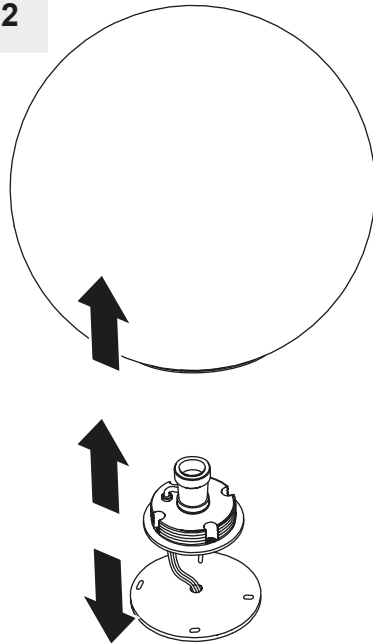

2



3

white/blanc/blanco		white/blanc/blanco
green/vert/verde		green/vert/verde
black/noir/negro		black/noir/negro

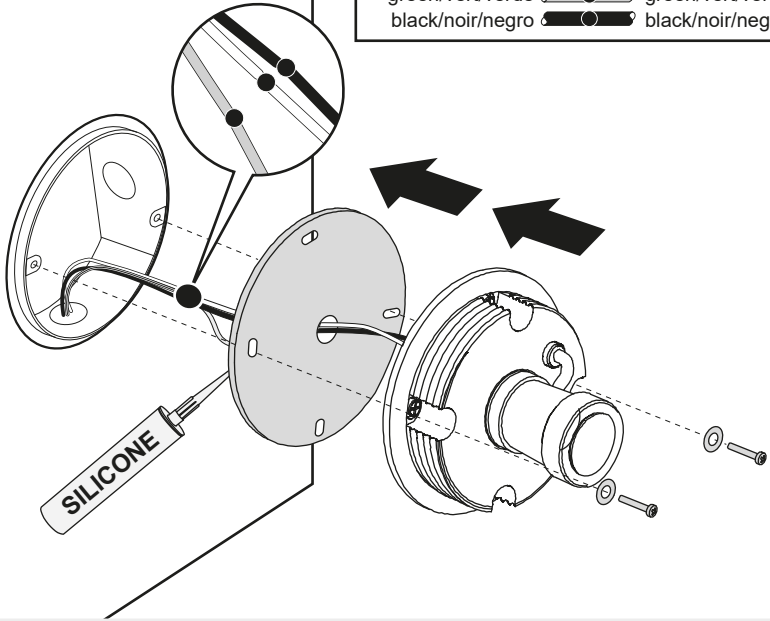

4

- Ø25** 1x max 100W TYPE G E26
- Ø35** 1x max 100W TYPE G E26
- Ø42** 1x max 150W TYPE A19 E26

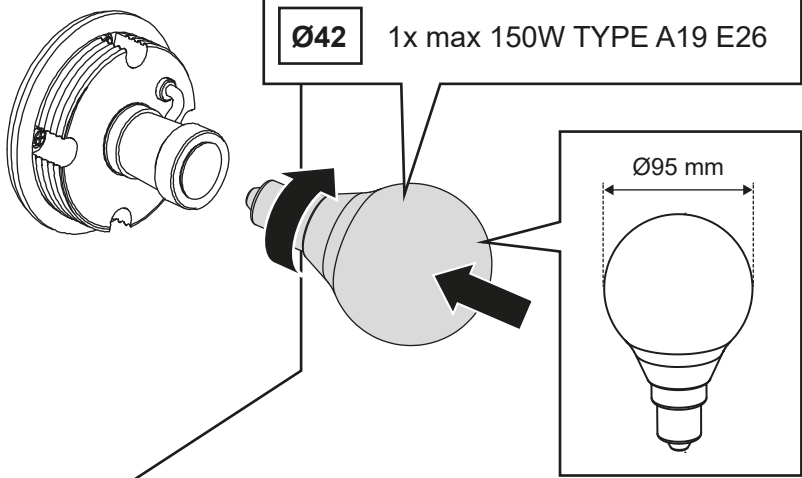

5

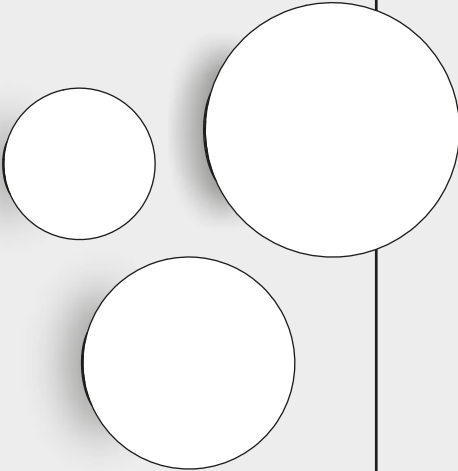
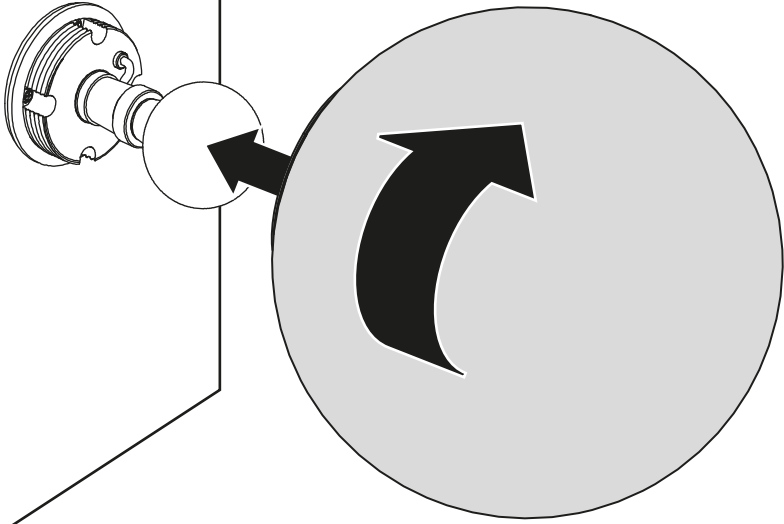

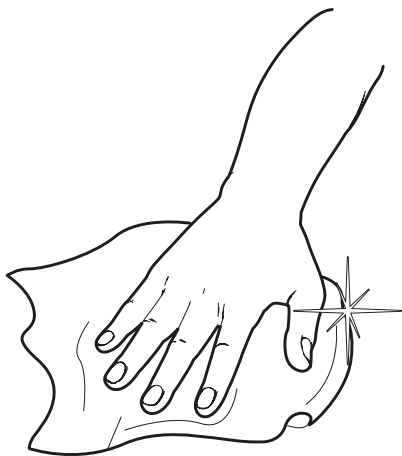

Artemide®



Artemide

via Bergamo, 18
20006 Pregnana M.se (MI)
ITALIA

tel. +39 02 935 181
fax +39 02 935 90 254
fax +39 02 935 90 496

www.artemide.com

VAT IT00846890150

Artemide Inc.

250 Karin Lane
Hicksville, NY 11801

tel. 631 694 9292
Toll Free 1-877-Art-9111
Fax 631 694 9275

www.artemide.net

Artemide Ltée/Ltd.

11105 rue Renaude Lapointe
Montréal, Québec H1J 2T4

Tel. 514 323 6537
Toll Free 888 777 2783
Fax 514 323 8864

www.artemide.net

cod. Y513000552