

# Artemide®

## Nur 1618 Acoustic Led

design  
Ernesto Gismondi

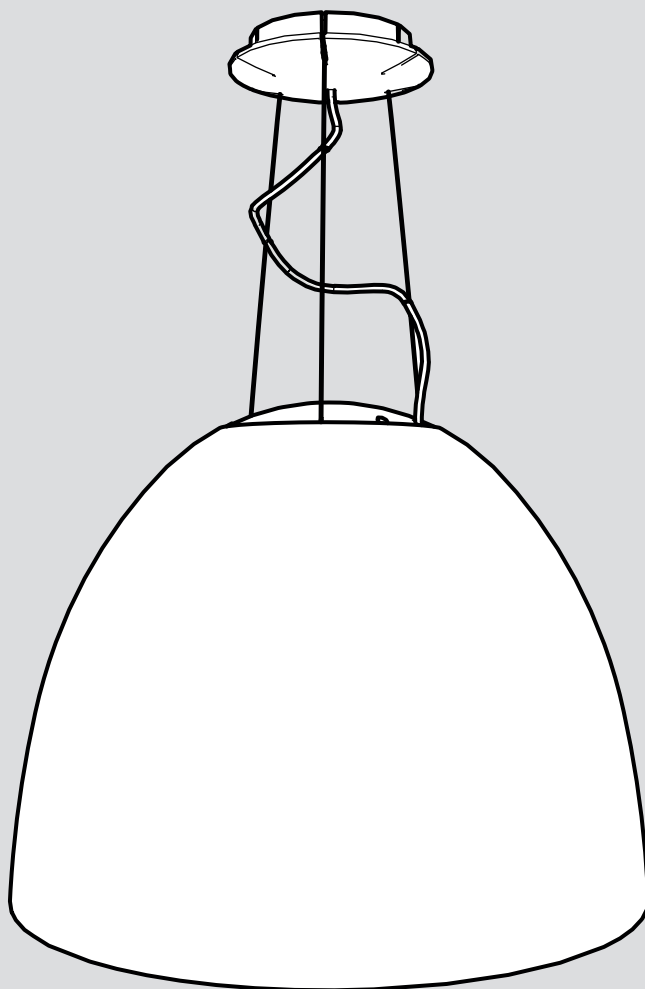



i

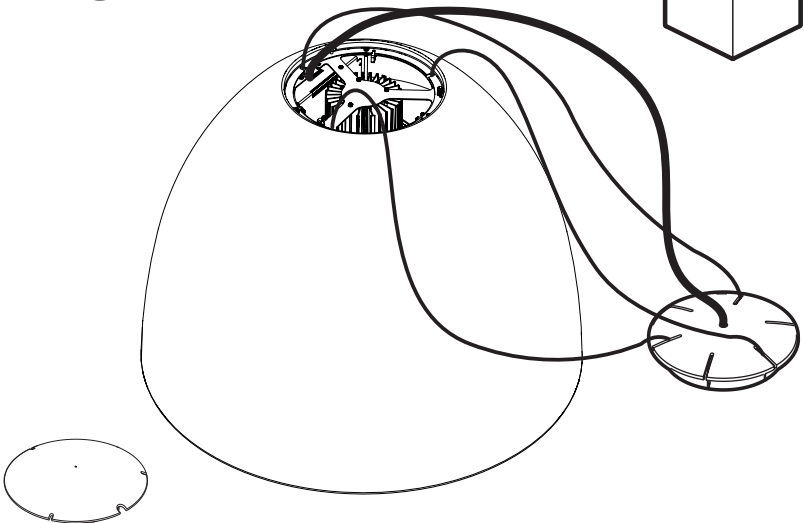
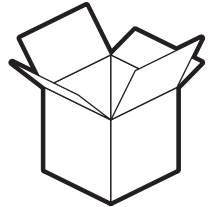

1

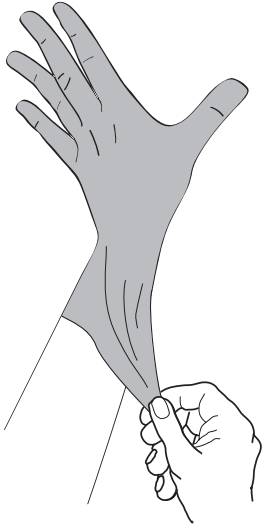

2

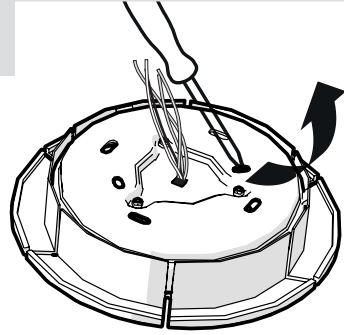

3

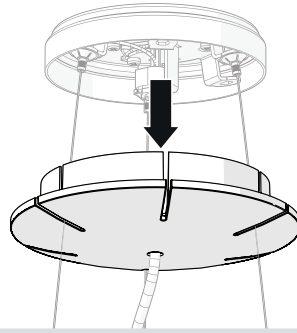

4

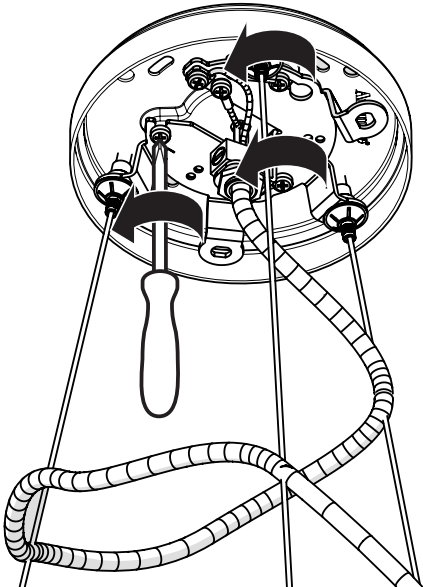

5

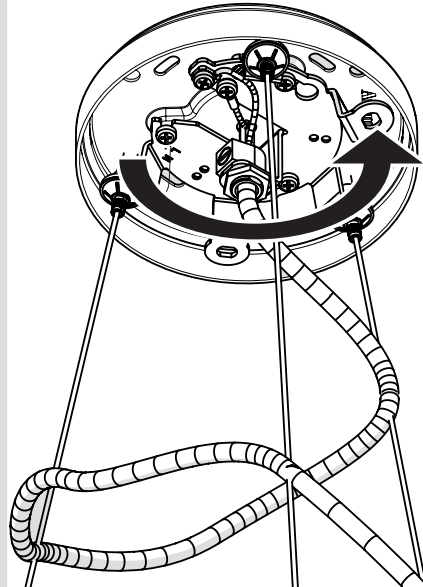

6a

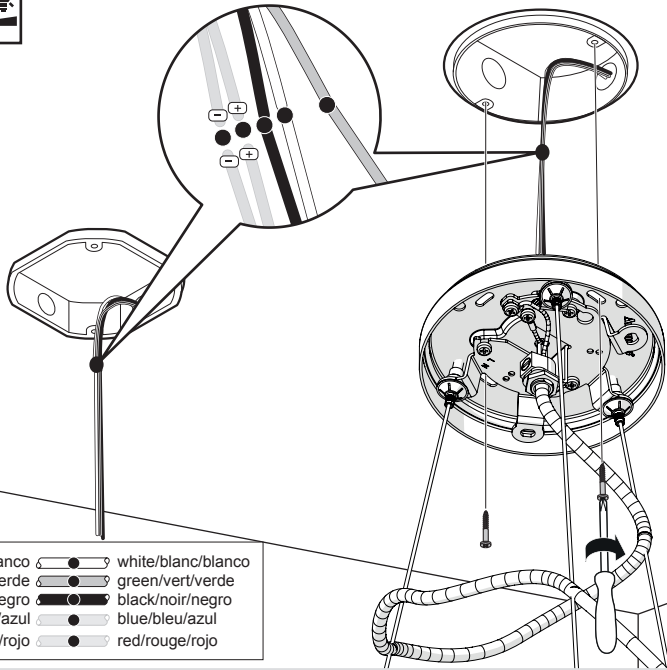

white/blanc/blanco	○●	white/blanc/blanco
green/vert/verde	○●	green/vert/verde
black/noir/negro	●○	black/noir/negro
blue/bleu/azul	○●	blue/bleu/azul
red/rouge/rojo	○●	red/rouge/rojo

6b

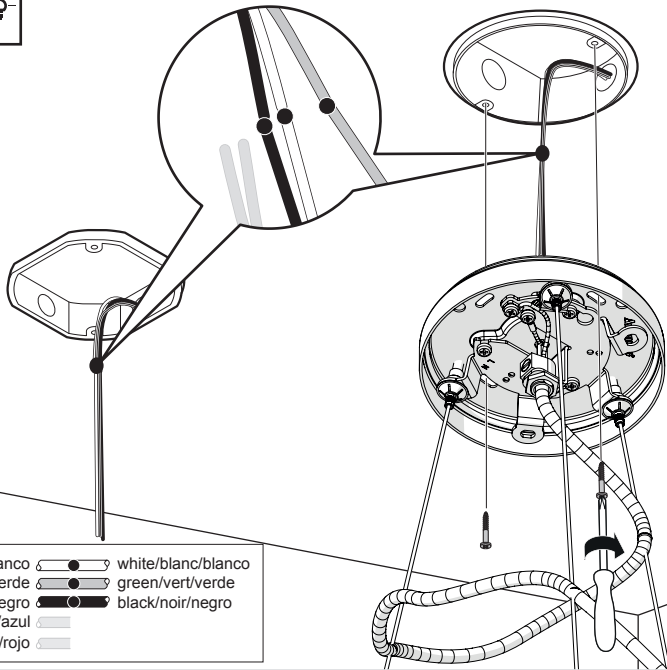

white/blanc/blanco	○●	white/blanc/blanco
green/vert/verde	○●	green/vert/verde
black/noir/negro	●○	black/noir/negro
blue/bleu/azul	○●	
red/rouge/rojo	○●	

**i**

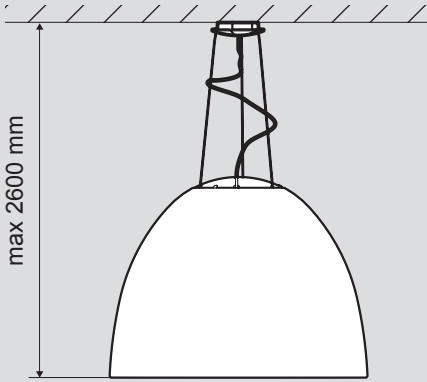

**7**

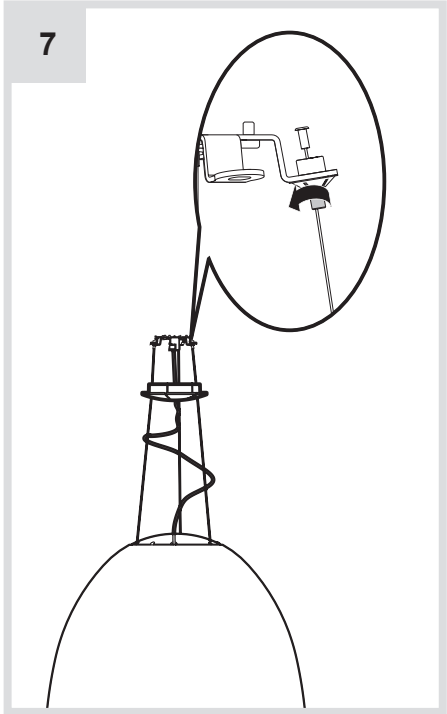

**8**

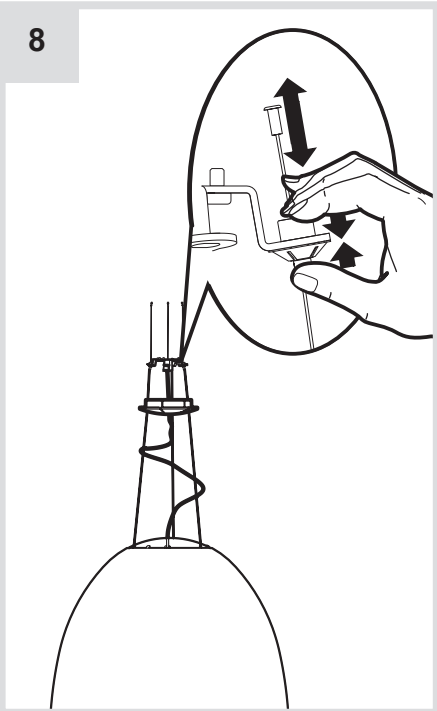

**9**

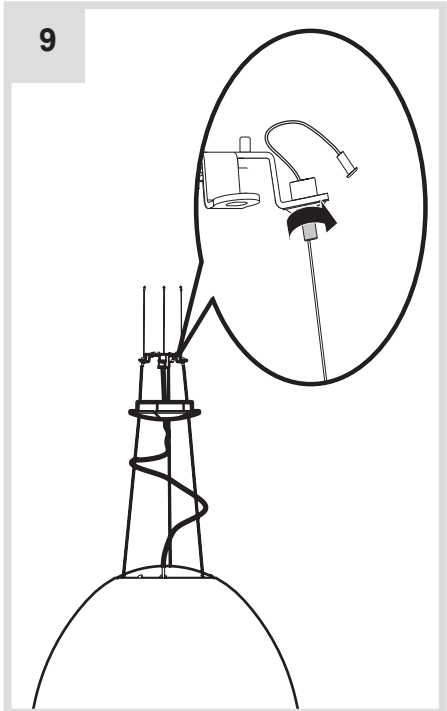

10

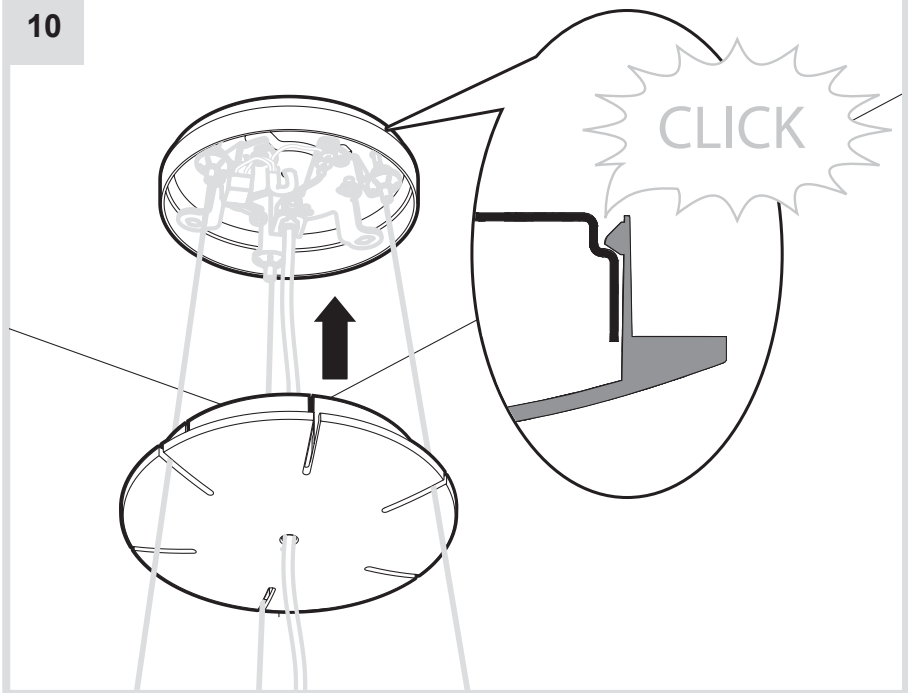

11

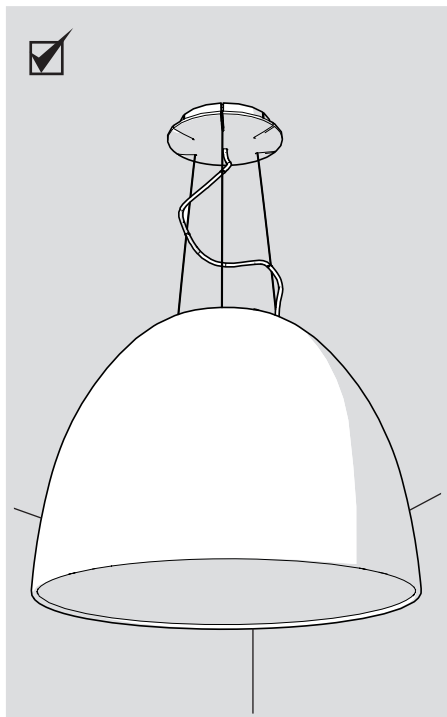
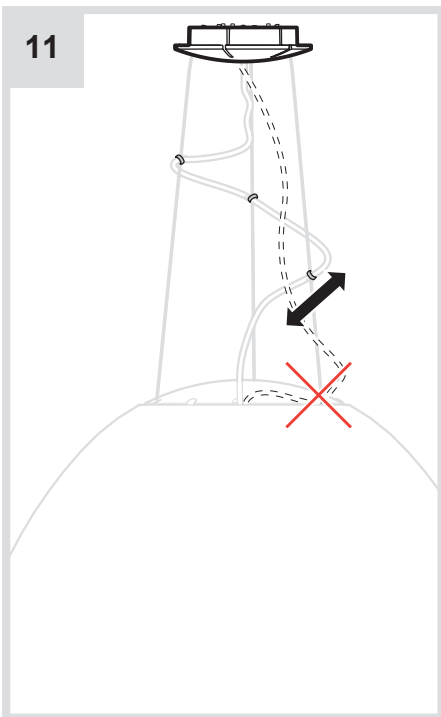

i



1

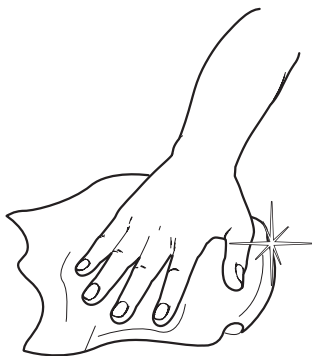

# Artemide®



## **Artemide**

via Bergamo, 18  
20010 Pregnana M.se (MI)  
ITALIA

tel. +39 02 935 181  
fax +39 02 935 90 254  
fax +39 02 935 90 496

[www.artemide.com](http://www.artemide.com)

VAT IT00846890150

## **Artemide Inc.**

250 Karin Lane  
Hicksville, NY 11801

Tel. 631 694 9292  
Toll Free 1-877-Art-9111  
Fax 631 694 9275

[www.artemide.net](http://www.artemide.net)

## **Artemide Ltée/Ltd.**

11105 rue Renaude Lapointe  
Montréal, Québec H1J 2T4

Tel. 514 323 6537  
Toll Free 888 777 2783  
Fax 514 323 8864

[www.artemide.net](http://www.artemide.net)

cod. Y513000514