



Pirce
Giuseppe Maurizio Scutellà



GIUSEPPE MAURIZIO SCUTELLÀ

Born in Italy in 1962, Giuseppe Maurizio Scutellà is an expert in die-cast molding for object design. Having created products for Ducati and Mercedes amongst others, Scutellà approaches lighting fixtures as appliances with a soul, choosing to emphasize their magic over practicality.



**NHN CORPORATION HEADQUARTERS,
BUNDANG-GU, SOUTH KOREA**

Project: NBBJ Samoo, NHN SPX Team

TECHNOLOGY

Pirce's award-winning design is one of Artemide's top sellers. Originally released in halogen, its light source has been reimagined to incorporate a high quality, energy-efficient LED light source.

**INTERGRAPH CORPORATE HEADQUARTERS,
HUNTSVILLE, ALABAMA, USA**

Project: Cooper Carry
Photo: Josh Meister



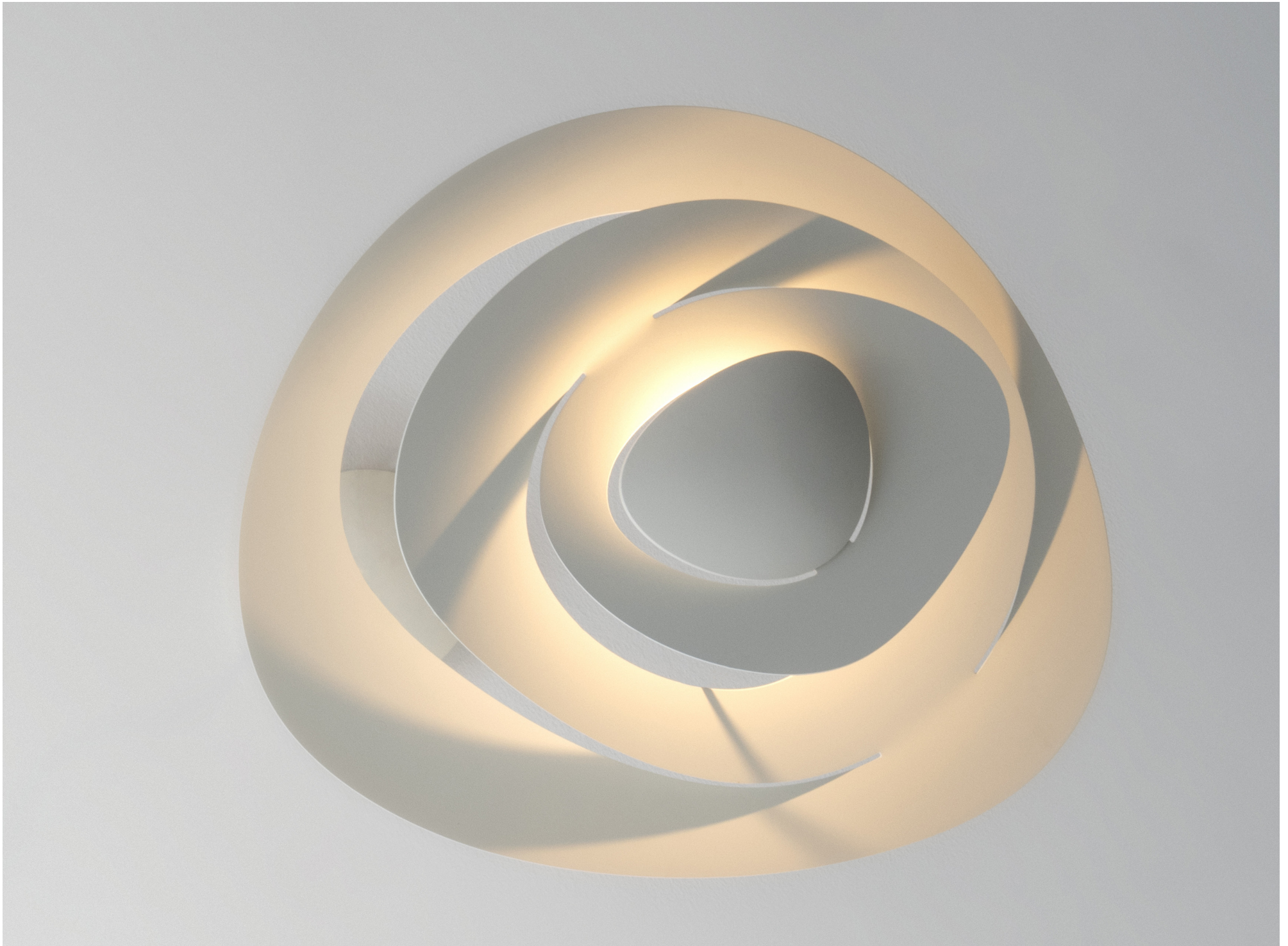

ELEGANCE

Pirce is not only an elegant light source, it is an alluring decoration with a strong sense of presence turned on or off. Its slim disc merges softly into flowing twirls that spiral downwards to create alluring lighting effects.





VERSATILITY

The Pirce collection of ceiling, suspension, and wall models comes in three different sizes available in white or black finishes. When these models are combined, Pirce complements any modern space with brilliant design consistency, whether residential or commercial.

ARCHITECT YOUR HOME

Project: Architect Your Home
Photo: Tim Mitchell

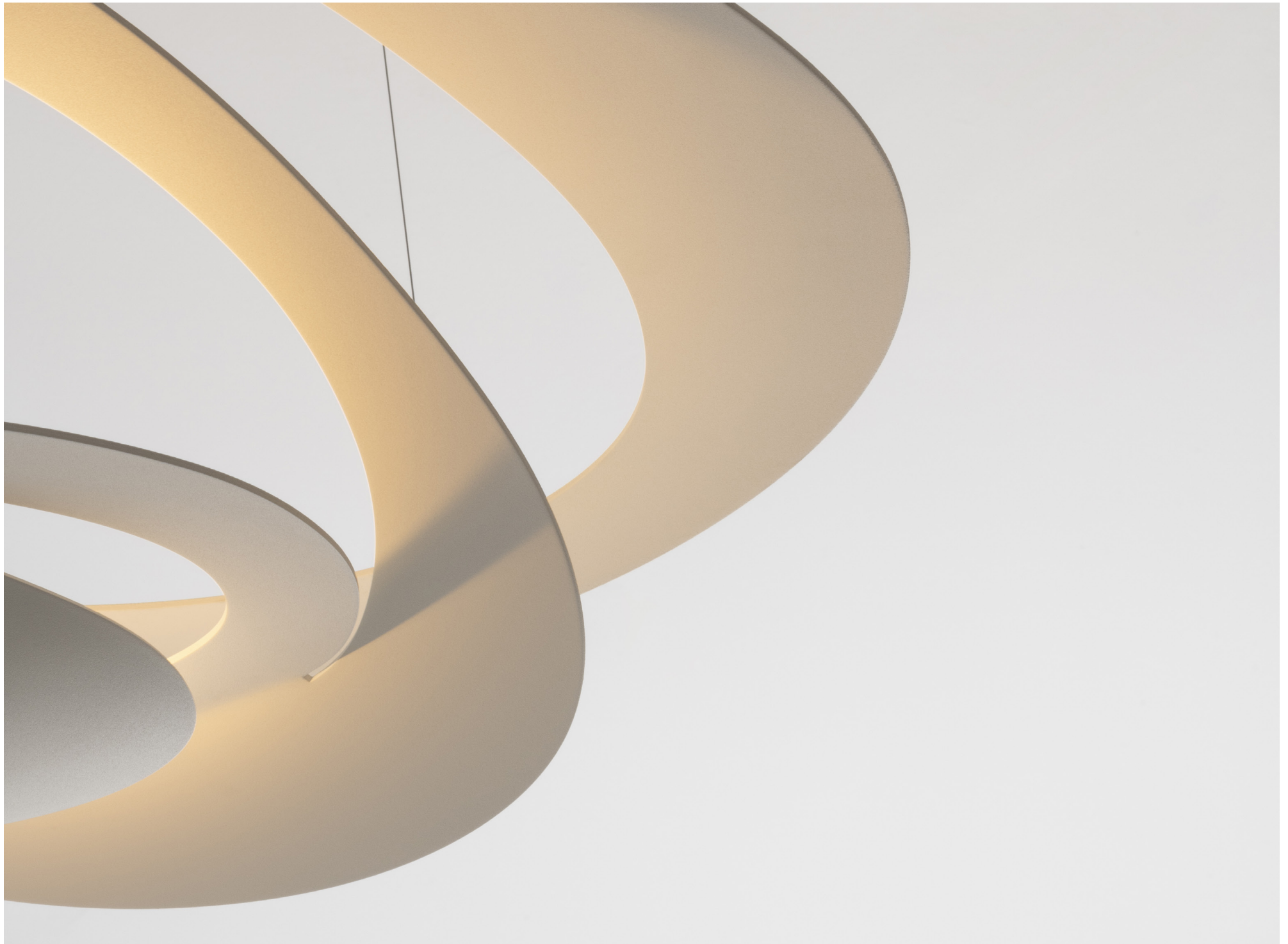

Pirce Ceiling



14 ³/₁₆"
36 cm

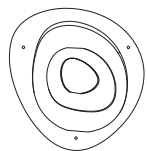

27 ³/₁₆"
69 cm

PIRCE MINI

MATERIALS	Flexible painted steel structure, covered with a natural anti-yellowing silicone case
EMISSION	Indirect
LIGHT SOURCE	LED 28W 2700K > 90CRI or LED 28W 3000K > 93CRI
DIMMING FEATURE	Dimmable
FINISH	○ White
CERTIFICATIONS	c.UL.us listed

Technical data

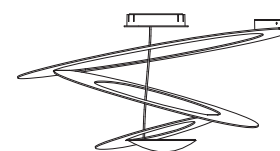

17 ⁵/₁₆"
44 cm

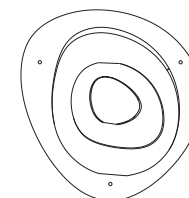

37 "
94 cm

PIRCE

MATERIALS	Flexible painted steel structure, covered with a natural anti-yellowing silicone case
EMISSION	Indirect
LIGHT SOURCE	LED 28W 2700K > 90CRI or LED 28W 3000K > 93CRI
DIMMING FEATURE	Dimmable
FINISH	○ White
CERTIFICATIONS	c.UL.us listed



Pirce Suspension

Technical data

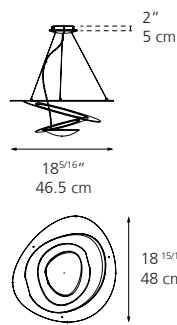
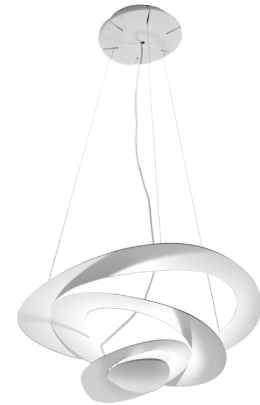
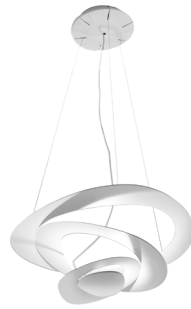

Standard length
 Min. 19^{3/4"} - Max. 84"
 Min. 50 cm - Max. 213.4 cm

Extended length
 Min. 19^{3/4"} - Max. 216"
 Min. 50 cm - Max. 548 cm

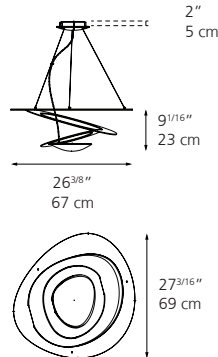

Standard length
 Min. 19^{3/4"} - Max. 84"
 Min. 50 cm - Max. 213.4 cm

Extended length
 Min. 19^{3/4"} - Max. 216"
 Min. 50 cm - Max. 548 cm

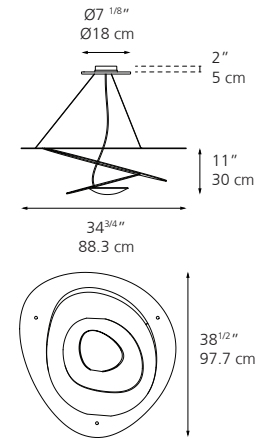

Standard length
 Min. 19^{3/4"} - Max. 84"
 Min. 50 cm - Max. 213.4 cm

Extended length
 Min. 19^{3/4"} - Max. 216"
 Min. 50 cm - Max. 548 cm

PIRCE MICRO

PIRCE MINI

PIRCE

MATERIALS	Flexible painted steel structure, covered with a natural anti-yellowing silicone case	Flexible painted steel structure, covered with a natural anti-yellowing silicone case	Flexible painted steel structure, covered with a natural anti-yellowing silicone case
EMISSION	Indirect	Indirect	Indirect
LIGHT SOURCE	LED 28W 2700K > 90CRI or LED 28W 3000K > 80CRI	LED 28W 2700K > 90CRI or LED 28W 3000K > 93CRI	LED 28W 2700K > 90CRI or LED 28W 3000K > 93CRI
DIMMING FEATURE	Dimmable	Dimmable	Dimmable
FINISH	○ White ● Gold	○ White ● Gold	○ White ● Gold
CERTIFICATIONS	c.UL.us listed	c.UL.us listed	c.UL.us listed



Pirce Wall



Technical data

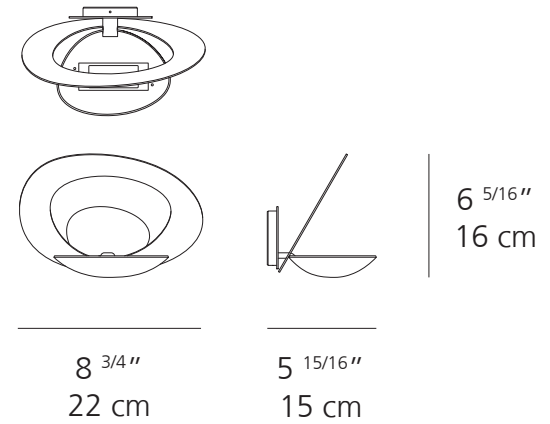

MATERIALS	Flexible painted steel structure, covered with a natural anti-yellowing silicone case
EMISSION	Indirect
LIGHT SOURCE	LED 28.3W 2700K > 90CRI or LED 28.3W 3000K > 80CRI
DIMMING FEATURE	Dimmable
FINISH	○ White
CERTIFICATIONS	c.UL.us listed



**HARD ROCK HOTEL,
TENERIFE, SPAIN,**

Project: Fiesta. Hotel & Resorts Hard Rock Hotel
Photo: Roberto de Lara

UNITED STATES HEADQUARTERS

Artemide Inc.

250 Karin Lane

Hicksville, NY 11801

T. 631-694-9292

Toll Free 1-877-Art-9111

email: infousa@artemide.net

CANADIAN HEAD OFFICE

Artemide Canada Ltd.

11105, rue Renaude Lapointe

Montréal, QC H1J 2T4

T. 514-323-6537

Toll Free 1-888-777-2783

email: infocanada@artemide.net

Artemide[®]

For retail sales contact information, please visit

www.artemide.net/store-locator

For contract sales contact information, please visit

www.artemide.net/sales-representative