

# Eggboard



**Artemide®**

# Eggboard

Giacobone & Roj - Progetto CMR  
2014

Eggboard is a resounding innovation, offering an efficient lighting solution with sound-absorbing properties. The intelligent fabric minimizes sound reflection and echo in a space, a feature that makes a difference in open spaces, especially in workspaces. Crafted of PET, a high quality material molded into a shape inspired from cardboard egg packaging, Eggboard is available in various colors, bringing a design accent to any office or commercial space.









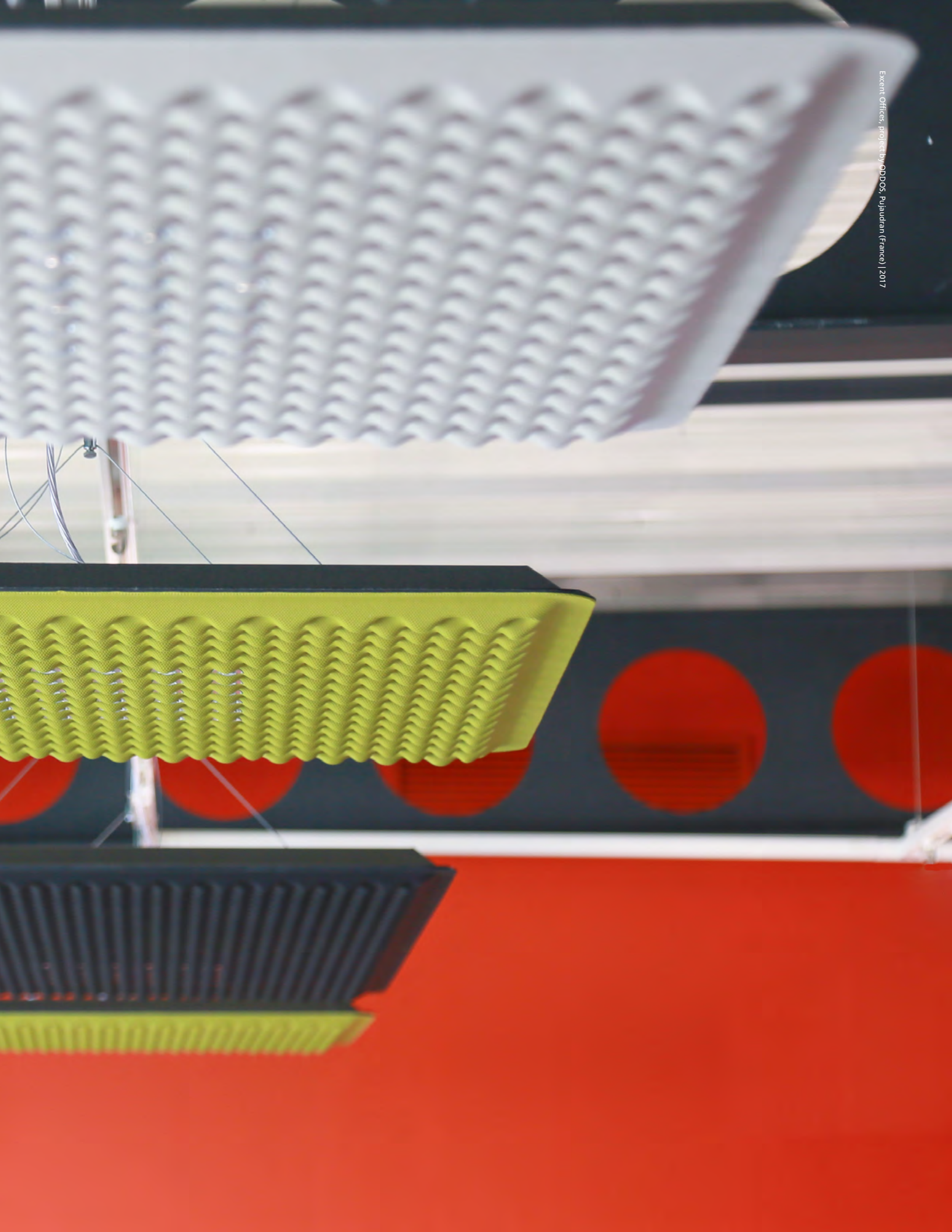







# Eggboard typologies

## SUSPENSION



EGGBOARD MATRIX  
1600X800 / 63"X31<sup>1</sup>/<sub>2</sub>"



EGGBOARD ACOUSTIC  
1600X800 / 63"X31<sup>1</sup>/<sub>2</sub>"



EGGBOARD MATRIX  
800X800 / 31<sup>1</sup>/<sub>2</sub>"X31<sup>1</sup>/<sub>2</sub>"



EGGBOARD ACOUSTIC  
800X800 / 31<sup>1</sup>/<sub>2</sub>"X31<sup>1</sup>/<sub>2</sub>"



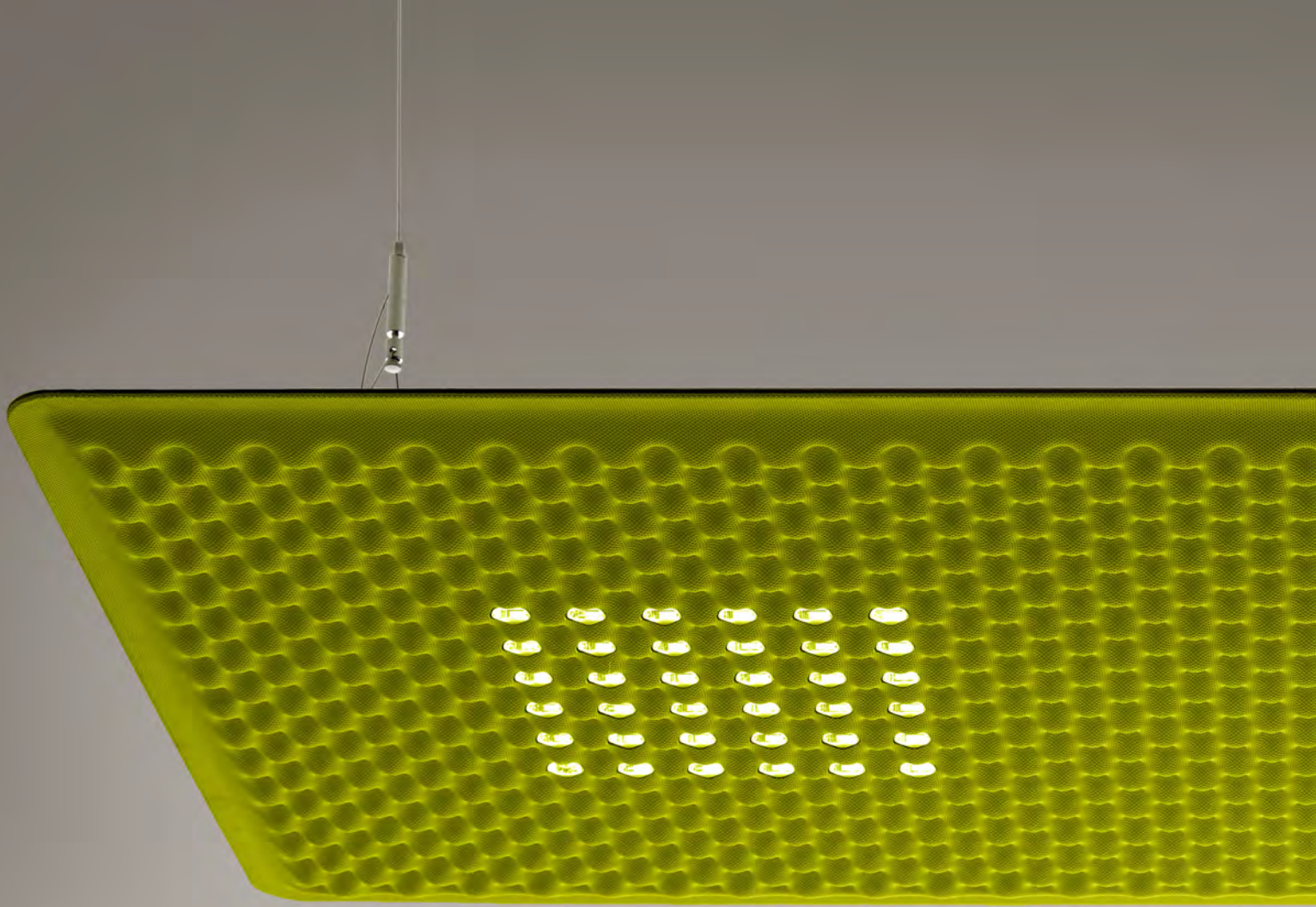

# Eggboard Matrix

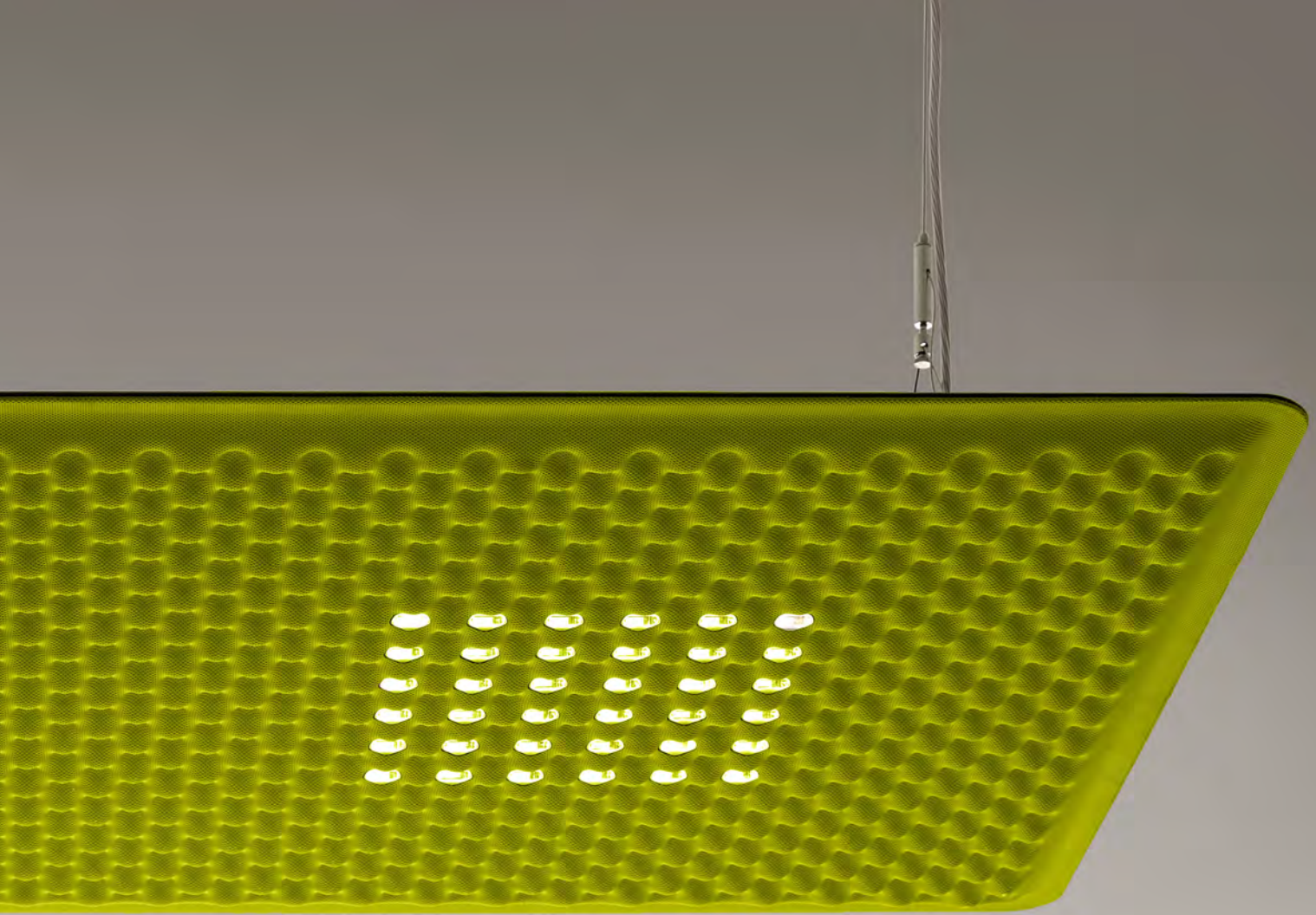

Suspension appliance with sound-absorbing properties ensured by an unusual sinusoidal cross-section design of the lower surface and the use of a sound-absorbing material.

Acoustic efficiency is ensured within a limited space by positioning at approximately three feet above the head of the speaker and listener.

Direct emission: a board with a high number of low-voltage LEDs ensures maximum lighting comfort.

Reflectors can be rotated for use on single or counterposed double desk.

Complies with the norms on office activities that involve the use of video-terminals (UGR<19).

Available in 3 colours (white, grey, green) and 2 different sizes (1600X800mm/63"X31<sup>1</sup>/<sub>2</sub>" - 800X800mm/31<sup>1</sup>/<sub>2</sub>"X31<sup>1</sup>/<sub>2</sub>").





# EGGBOARD MATRIX 1 DESK

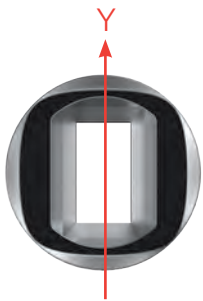
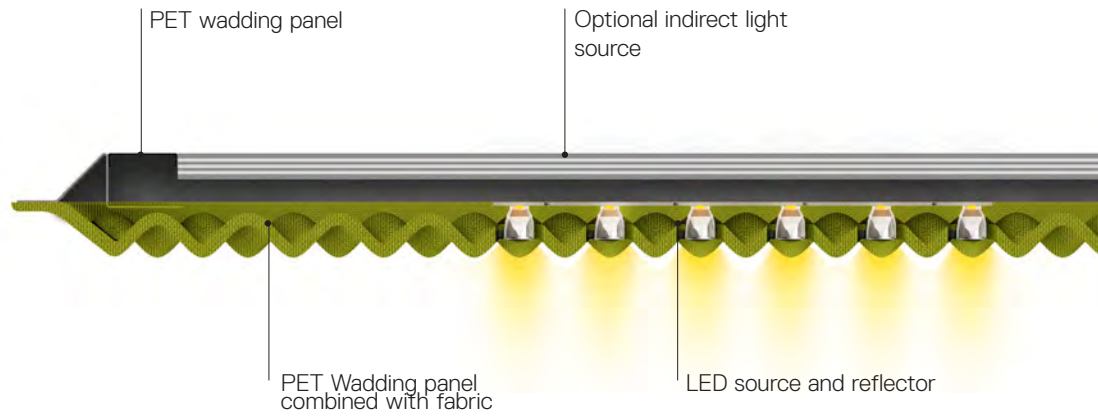
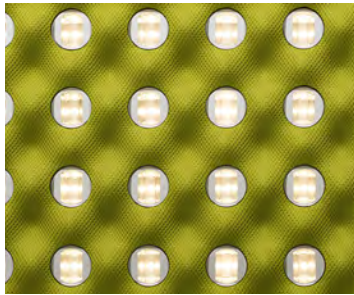

Rotating the elliptic-beam reflector along the Y axis allows to use the product to illuminate one workstation.

UGR < 12

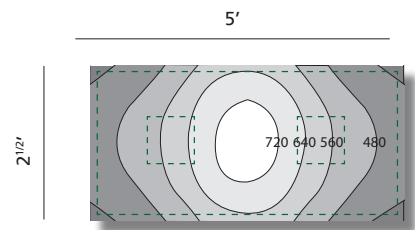



# EGGBOARD MATRIX 2 DESK

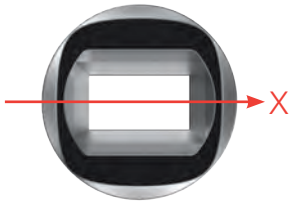
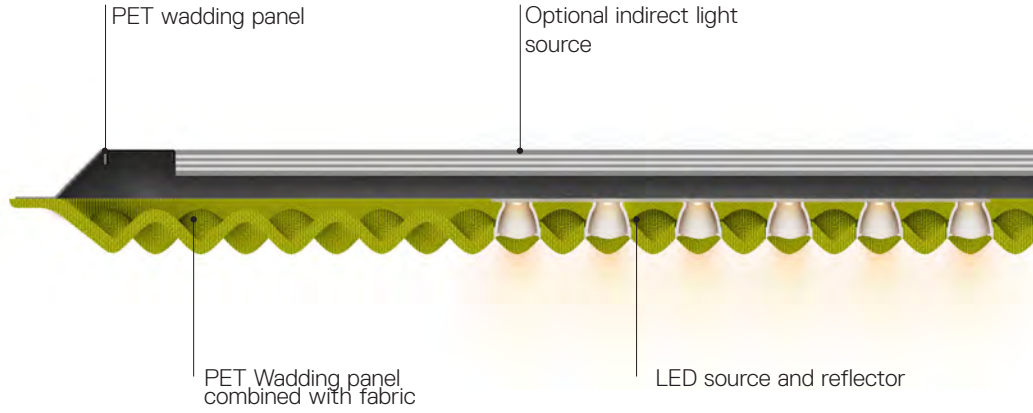
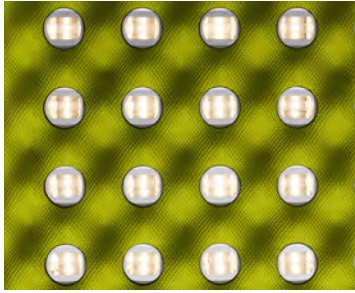

Rotating the elliptic-beam reflector along the X axis allows to use the product to illuminate two workstations.

UGR < 17

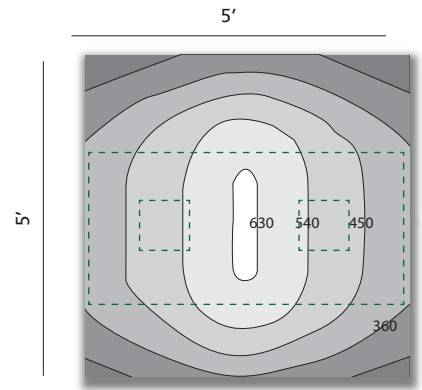

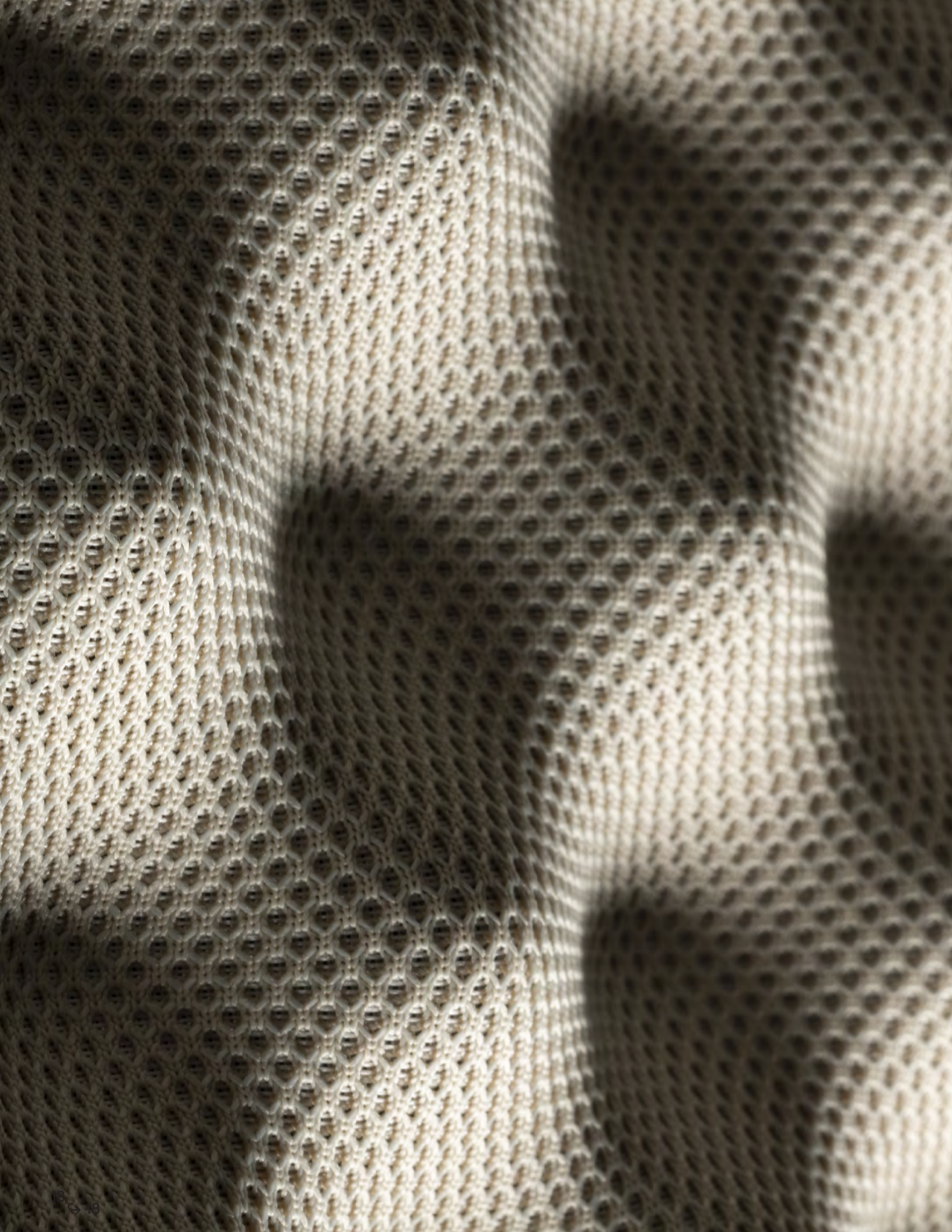

# EGGBOARD ACOUSTIC PANEL

The sound-absorbing material acts by reducing the reverberation time (i.e. the time required to reduce any noise inside the room by 60 db, so as to ensure that any echoes due to reflections on the walls are inaudible).

The frequency of human voice typically ranges from 1 to 4 kHz.

The use of materials capable to reduce these frequencies allows better understanding of speech and prevents the need to talk loudly to cover the background noise.

The sound-absorbing appliance should be located 15 to 24 inches off the ceiling to ensure optimal operation.

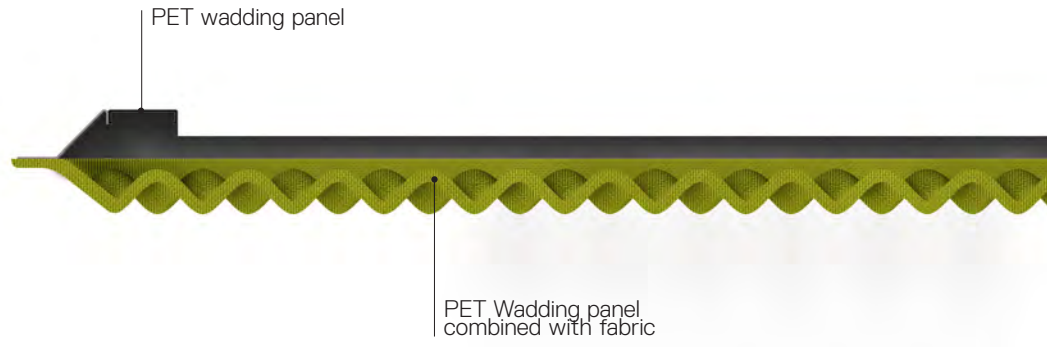

— No sound-absorbing material

— Noise reduction with Eggboard installed 2 feet of the ceiling

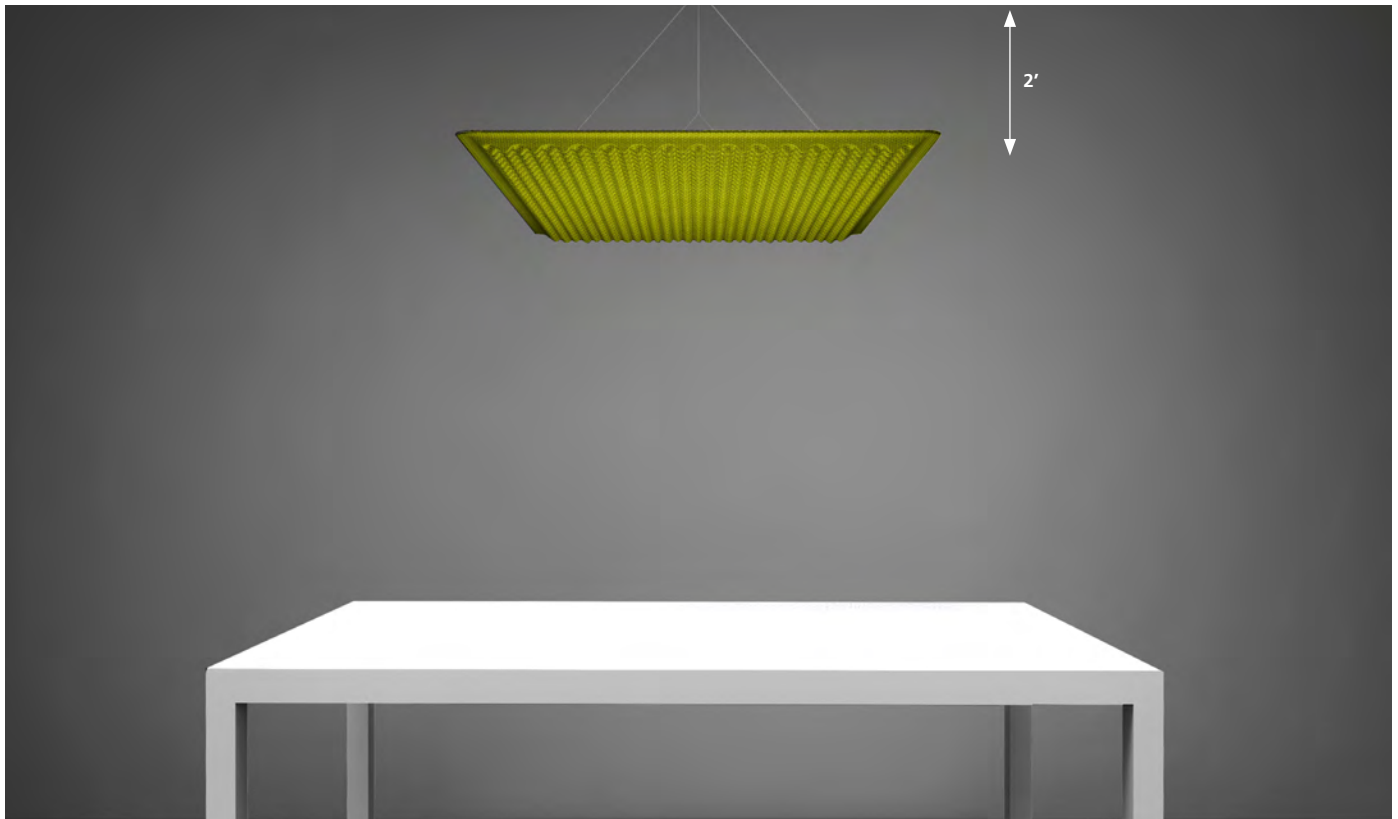
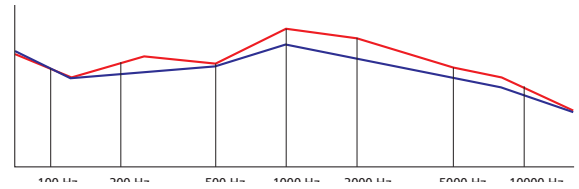

# EGGBOARD MATRIX

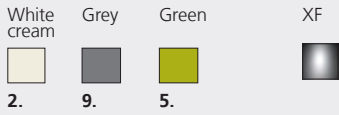

120/277Vac 50/60Hz  
built-in electronic driver

MacAdam 3SDMC  
Life L70(6K) 50000h  
CRI=90

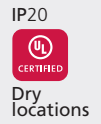

1600x800 / 63"X31 1/2"

### Direct

W	Beam	Flux	CCT
31 W	XF	2982 lm	3000 K
		2982 lm	3500 K

### Dimmable 0-10V

Code  
**M3100W.** [2/9/5 .18](#)  
**M3100C.** [2/9/5 .18](#)

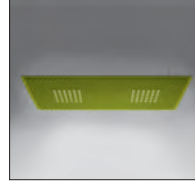

### Direct + Indirect

W	Beam	Flux	CCT
75W	XF	2982 lm direct	3000 K
		4714 lm indirect	
		2982 lm direct	3500 K
		4714 lm indirect	

### Dimmable 0-10V

Code  
**M3101W.** [2/9/5 .18](#)  
**M3101C.** [2/9/5 .18](#)

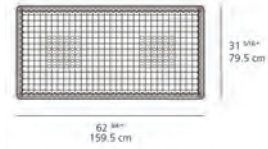

### Without light

Code  
**M3108.** [2/9/5 .0](#)

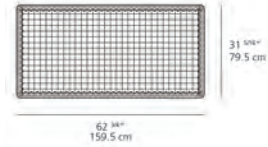

800x800 / 31 1/2"X 31 1/2"

### Direct

W	Beam	Flux	CCT
16 W	XF	1491 lm	3000 K
		1491 lm	3500 K

### Dimmable 0-10V

Code  
**M3102W.** [2/9/5 .18](#)  
**M3102C.** [2/9/5 .18](#)

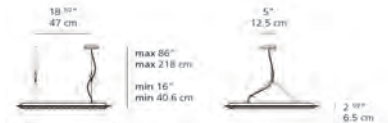

### Direct + Indirect

W	Beam	Flux	CCT
75W	XF	1491 lm direct	3000 K
		2357 lm indirect	
		1491 lm direct	3500 K
		2357 lm indirect	

### Dimmable 0-10V

Code  
**M3103W.** [2/9/5 .18](#)  
**M3103C.** [2/9/5 .18](#)

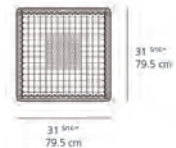

### Without light

Code  
**M3109.** [2/9/5 .0](#)

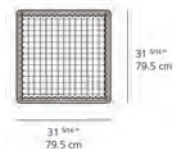



MORE HAPPINESS WITH LESS STUFF, ALL MADE SUSTAINABLY. RAY ANDERSON



Notausstieg

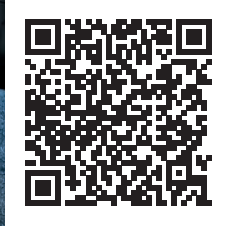





## Artemide INC

250 Karin Lane  
Hicksville, NY 11801  
Tel. 631-694-9292  
[artemide.net](http://artemide.net)

## Artemide Ltd

11105 rue Renaude Lapointe  
Montréal, Québec, H1J 2T4  
Tel. 514-323-6537  
[artemide.net](http://artemide.net)



ISO 9001:2015



ISO 14001:2015



ISO 45001:2018

### Artemide INC - Artemide Ltd

Reserves right to change, at any time and without prior warning, the technical specifications of any product illustrated in this catalogue.

### Artemide INC - Artemide Ltd

Se réserve le droit de modifier, à n'importe quel moment et sans préavis, les caractéristiques techniques des éléments illustrés dans ce catalogue.

### Artemide INC - Artemide Ltd

Se reserva la facultad de modificar, en cualquier y sin aviso previo, las características técnicas de los elementos ilustrados en el presente catálogo.